

Overvoltage Protection

OVR Range

2CTC432001C0201

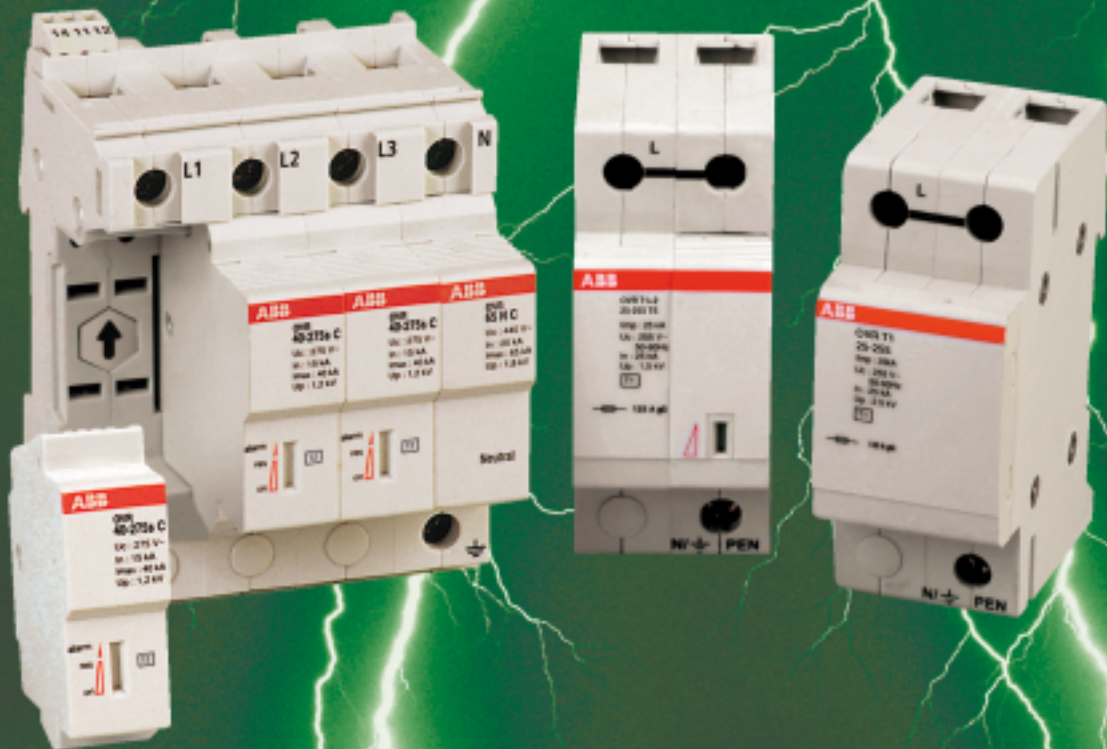

The ABB logo, consisting of the letters 'ABB' in a bold, red, sans-serif font.

ABB OVR Range Summary

Contents

General points on lightning and its risks

Causes of transient overvoltages	3
ABB: lightning and overvoltage protection solutions	5
Diagram of an installation protected against lightning and its indirect effects	6
Terminology of electrical characteristics	7
Earthing systems	10
Common mode and/or differential mode protection	11

Choosing a surge arrester

When must we be protected?	14
Choosing the type of protection according to the network	15
Choice of I_n , I_{max} , I_{imp}	16
The principle of coordination	17
Options: end of life indicator, pluggable, Safety reserve, TS, Optical monitoring block	18
Example of a protected industrial installation	19

ABB surge arrester range

Power supply surge arresters	20
Telecom and dataline protection surge arresters	42

Installation rules for surge arresters

Choice of associated breaking device (fuse / circuit-breaker)	45
Connecting the breaking device	46
Choice of disconnecter (fuse / circuit-breaker)	47
Wiring diagrams according to the earthing system (TT, IT, TNS, TNC)	48
Cabling and installation of surge arresters in an electrical panel	50
Index by reference	51
Index by code	52

General points on lightning and its risks

The most serious consequences of lightning are the death of people and farm animals, and the destruction of equipment: telephone lines, transformers connected to the electrical distribution network, electrical meters, household appliances, etc.
At the same time, the growing amount of equipment incorporating very sensitive electronic devices increases the number of incidences linked to lightning.

Within companies, if office automation equipment or machines (in factories) are put out of action, it nearly always leads to operating losses, the cost of which is much more than that of the damaged equipment.

For example, if a bank's computers are no longer operational, it suffers large operating losses. For the general public, the damage is mainly material: computer, household appliances, home cinema, etc.

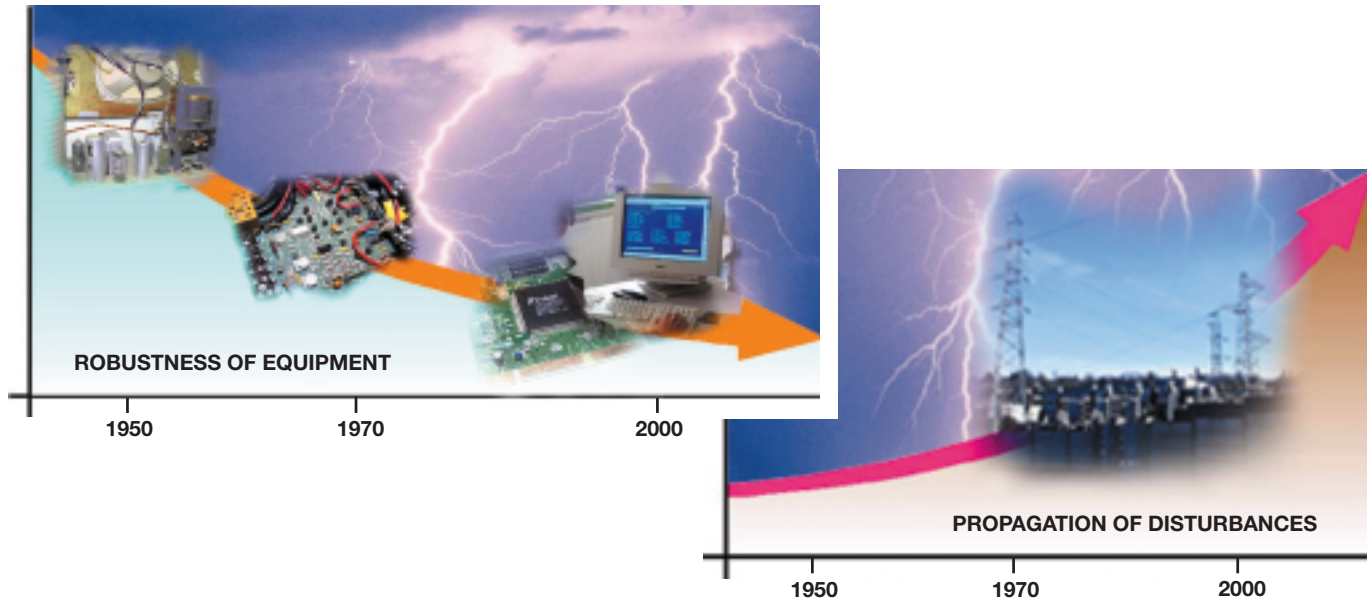

Causes of transient overvoltages

A transient overvoltage is a voltage peak with a maximum duration of less than one millisecond. There are two possible causes of overvoltages on electrical networks:

- natural causes (lightning),
- other causes due to equipment or switching devices.

Natural overvoltages on low voltage networks are caused by direct lightning strikes. The high level of energy contained in a direct lightning strike on a lightning conductor or an overhead low voltage line leads to considerable damage of the installation. The overvoltage can be over 20 times the nominal voltage.

Operating or switching overvoltages linked to a network's equipment create overvoltages of a lower level (3 to 5 times the nominal voltage) but occur much more frequently, thus causing premature ageing of the equipment.

Three categories of overvoltage propagate on low voltage networks:

- direct lightning strikes,
- indirect effects of lightning strikes,
- operating or switching overvoltages.

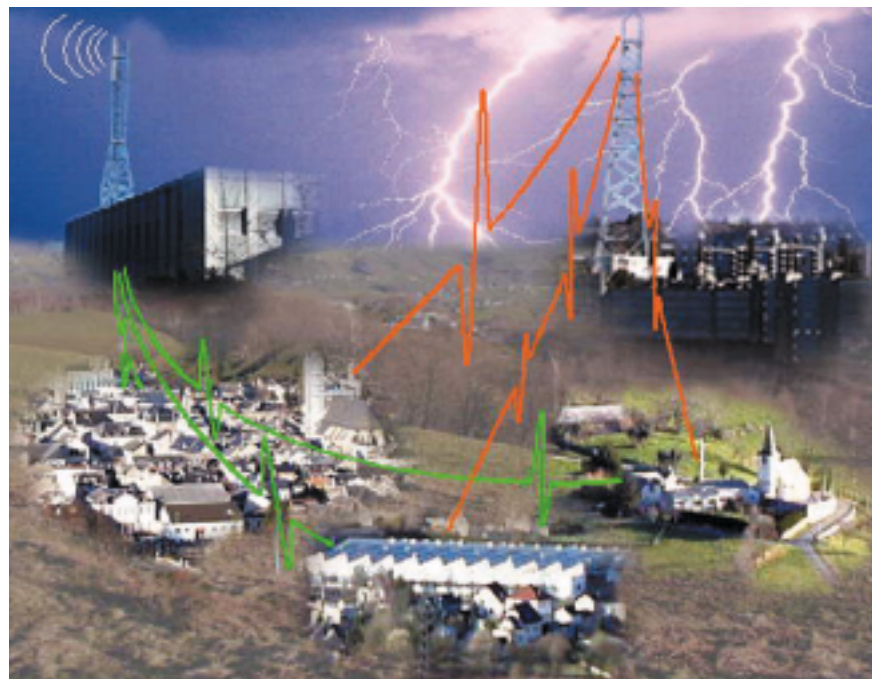

Propagation of overvoltages by electrical networks (power and low current)

General points on lightning and its risks

Causes of transient overvoltages

Overvoltages due to direct lightning strikes

These can take two forms:

- When lightning **strikes a lightning conductor or the roof of a building** which is earthed, the lightning current is dissipated into the ground. The impedance of the ground and the current flowing through it create large difference of potential: this is the overvoltage. This overvoltage then propagates throughout the building via the cables, damaging equipment along the way.
- When lightning **strikes an overhead low voltage line**, the latter conducts high currents which penetrate into the building creating large overvoltages. The damage caused by this type of overvoltage is usually spectacular (e.g. fire in the electrical switchboard causing the destruction of buildings and industrial equipment) and results in explosions.



Direct lightning strike on a lightning conductor or the roof of a building



Direct lightning strike on an overhead line

Overvoltages due to the indirect effects of lightning strikes

The overvoltages previously mentioned are also found when lightning strikes in the vicinity of a building, due to the increase in potential of the ground at the point of impact. The electromagnetic fields created by the lightning current generate inductive and capacitive coupling, leading to other overvoltages.

Within a radius up to several kilometres, the electromagnetic field caused by lightning in clouds can also create sudden increases in voltage. Although less spectacular than in the previous case, irreparable damage is also caused to so called sensitive equipment such as fax machines, computer power supplies and safety and communication systems.



Increase in ground potential



Magnetic field



Electrostatic field

General points on lightning and its risks

Causes of transient overvoltages

Overvoltages due to operating or switching actions

Equipment containing electronic switching components is also likely to generate electrical disturbances comparable to overvoltages. The consequences of which on sensitive equipment, albeit not visible, are no less detrimental: premature ageing and unpredictable or fleeting breakdowns.

Operating overvoltages are produced when reactive or capacitive equipment is switched on and off. Furthermore, interrupting factory production, lighting or transformers can generate overvoltages which will themselves cause greater damage to nearby electrical equipment.

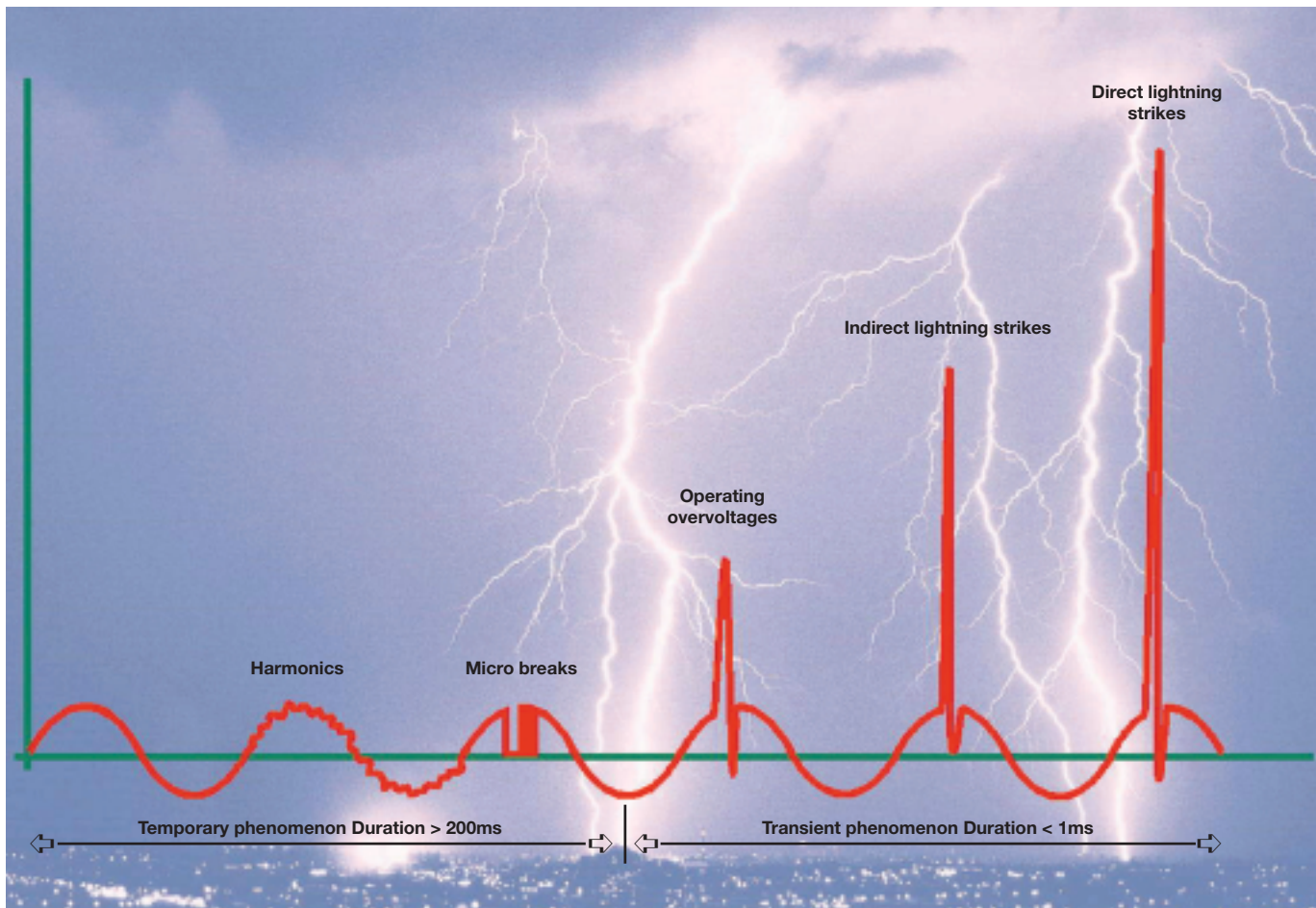

Representation of the various disturbances on electrical networks

General points on lightning and its risks

ABB : lightning and overvoltage protection solutions

With its experience gained over the last few decades, ABB at Bagnères-de-Bigorre in the Hautes Pyrénées region (South West of France) is using its technological expertise for lightning and overvoltage protection.

In April 2003, ABB acquired a new laboratory with several generators enabling the impact of a direct lightning strike (10/350 impulse wave) or an indirect lightning strike (8/20 impulse wave) to be tested in real conditions.

Through its wide product range, ABB is able to offer solutions to protect power and low current networks.

Seminars at ABB's new training centre are suited to the needs of all professionals: design offices, architects, distributors, electricians, sales staff.

These training sessions combine practical and theoretical aspects and cover a varied range of topics such as direct impact protection, overvoltage protection and electromagnetic compatibility.

THE LABORATORY IN PICTURES



- **High power generator**
Standardized 8/20 and 10/350 impulse waves.
Maximum shock current 100 kA for the two waves, superimposed on the electrical network.
Stored energy 800 kJ.



- **200 kV generator**
1.2/50 impulse wave.
Maximum voltage 200 kV.
Stored energy 10 kJ.



- **Hybrid generator**
Standardized 8/20 - 1.2/50, impulse wave 30 kV maximum, 30 kA maximum.
Stored energy 5 kJ.



- **Mechanical tests**
On-load operating test of sockets and strips.

- **Electrical tests**
440 V, 5000 A short circuit testing.



- **The ABB Laboratory in the Southwest of France.**

General points on lightning and its risks

Diagram of an installation protected against lightning and its indirect effects

The **Type 1 surge arrester (OVR T1)**, fitted in the installation's main incoming electrical switchboard, is capable of deviating the energy of a direct lightning strike. This is the first stage of the electrical network's protection.

The behaviour of the cables, subjected to a transient signal, limits the effectiveness of a surge arrester to 10 m. It is therefore necessary to use one or more surge arresters in the installation in order to obtain the required level of protection for the equipment.

Here, a **Type 2 surge arrester** should be used in coordination with the incoming surge arrester. This is the second stage of the protection.

Finally, if there is a risk of overvoltage on the electrical network, this risk also exists for the auxiliary wiring network. The appropriate protection is a surge arrester designed to protect telephone or data transmission lines (**OVR TC**). This is fitted in series on the network.

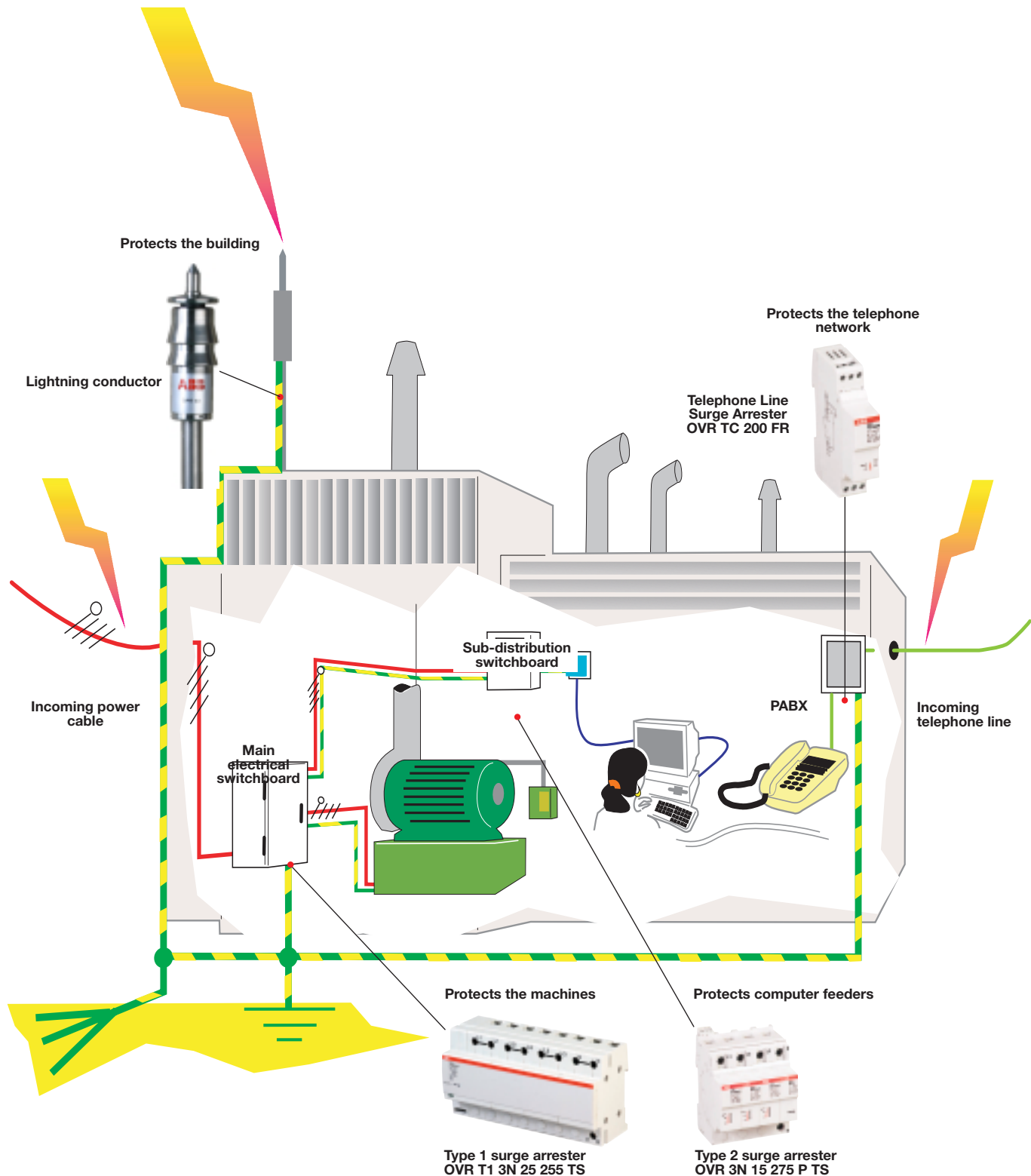

General points

Terminology of electrical characteristics

Surge arrester:

Device designed to limit transient overvoltages and run-off lightning currents. It consists of at least one non-linear component. It must comply with European standard EN 61643-11.

1.2/50 wave:

Standardized overvoltage waveform created on networks and which adds to the network's voltage.

8/20 wave:

Current waveform which passes through equipment when subjected to an overvoltage (low energy).

10/350 wave:

Current waveform which passes through equipment when subjected to an overvoltage due to a direct lightning strike.

Type 1 surge arrester:

Surge arrester designed to run-off energy caused by an overvoltage comparable to that of a direct lightning strike. It has successfully passed testing to the standard with the 10/350 wave (class I test).

Type 2 surge arrester:

Surge arrester designed to run-off energy caused by an overvoltage comparable to that of an indirect lightning strike or an operating overvoltage. It has successfully passed testing to the standard with the 8/20 wave (class II test).

U_p :

Voltage protection level.

Parameter characterising surge arrester operation by the level of voltage limitation between its terminals and which is selected from the list of preferred values in the standard. This value is greater than the highest value obtained during voltage limitation measurements (at I_n for class I and II tests).

I_n :

Nominal discharge current.

Peak current value of an 8/20 waveform (15 times) flowing in the surge arrester. It is used to determine the U_p value of the surge arrester.

I_{max} :

Maximum discharge current for class II testing.

Peak current value of an 8/20 waveform flowing in the surge arrester with an amplitude complying with the class II operating test sequence.

I_{max} is greater than I_n .

I_{imp} :

Impulse current for class I testing.

The impulse current I_{imp} is defined by a peak current I_{peak} and a charge Q , and tested in compliance with the operating test sequence. It is used to classify surge arresters for class I testing (the 10/350 wave corresponds to this definition).

U_n :

Nominal AC voltage of the network : nominal voltage between phase and neutral (AC rms value).

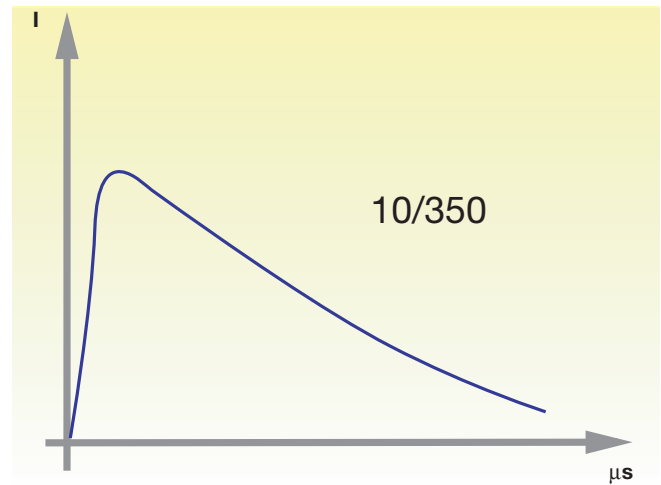

Type 1 Surge Arresters
 I_{imp} : current wave

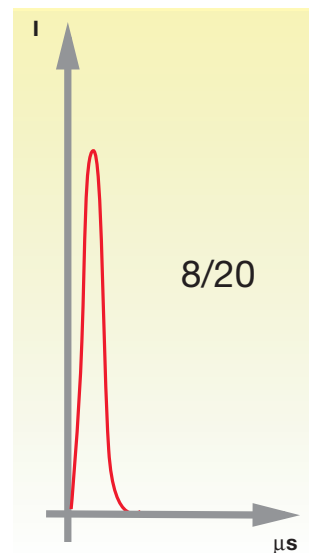

Type 2 Surge Arresters
 I_{max} : current wave

General points

Terminology of electrical characteristics

U_c :

Maximum continuous operating voltage (IEC 61643-1).

Maximum rms or dc voltage which can be continuously applied in surge arrester protection mode. It is equal to the rated voltage.

N_g :

Lightning strike density expressed as the number of ground lightning strikes per km² and per year.

U_T :

Temporary overvoltage withstand.

Maximum rms or dc overvoltage that the surge arrester can be subjected to and which exceeds the maximum voltage for continuous operation U_c for a specified time.

I_{fi} :

Follow current interrupting rating I_{fi} (kArms).

It is a parameter for spark-gaps and gas discharge tubes (Type 1 SPDs) and does not concern varistors. I_{fi} is the rms-value of the follow current, which can be interrupted by the SPD under U_c . It is the prospective short-circuit current that a SPD is able to interrupt by itself. I_{fi} of the SPD should be equal to or higher than the prospective short-circuit current at the point of installation (I_p). If not, the upstream fuse will melt each time the spark-gap ignites.

I_p :

Prospective short-circuit current of a power supply (I_p) (kArms).

I_p is the current which would flow at a given location in case of short-circuit at this location.

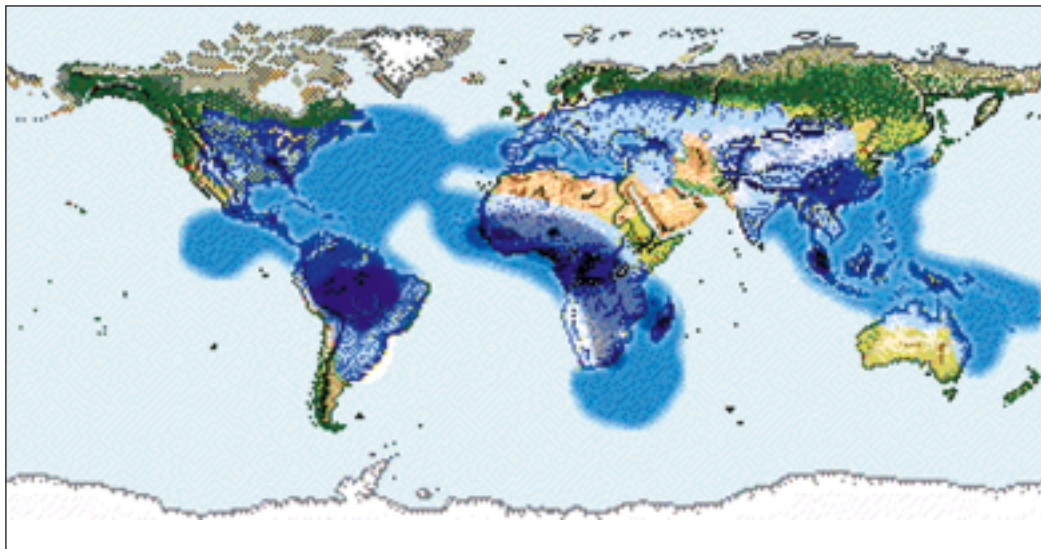

Protection mode

Common mode (MC): protection between live conductors and earth.

Differential mode (MD): protection between phase and neutral conductors.

General points

Terminology

Impulse withstand voltage of equipment

Equipment tolerance levels are classified according to 4 categories (as indicated in the following table) according to IEC 60364-4-44, IEC 60664-1 and IEC 60730-1.

Categories	U_n		Examples
	230 / 400 V	400 / 690 V	
I	1500 V	2500 V	Equipment containing particularly sensitive electronic circuits : – computer workstations, computers, TV, HiFi, Video, Alarms, etc; – household appliances with electronic programmers, etc.
II	2500 V	4000 V	Domestic electrical equipment with mechanical programmers, portable tools, etc.
III	4000 V	6000 V	Distribution panels, switchgear (circuit-breakers, isolators, power socket bases, etc.), ducting and its accessories (cables, busbars, junction boxes, etc.).
IV	6000 V	8000 V	Equipment for industrial use and equipment such as fixed motors permanently connected to the fixed installation, Electrical meters, principle overcurrent protection equipment, remote measurement devices, etc.

Whatever the type of overvoltage protection used, the maximum voltage corresponds to category II.

$U_p \text{ max} = 2500 \text{ V}$ if $U_n = 230 \text{ V}$.

However, it should be noted that some equipment requires a particularly low protection level.

E.g. medical equipment, UPSs (with very sensitive electronics) $U_n < 0.5 \text{ kV}$.

The protection level U_p is chosen according to the equipment to be protected.

Note:

In certain cases, protection components can be integrated into the equipment.

In this case, the manufacturer must communicate the type of protection that has been integrated.

8/20 and 10/350 impulse waves

The first number corresponds to the time from 10% to 90% of its peak value, e.g. 8 μs .

The second number corresponds to the time taken for the wave to descend to 50% of its peak value, e.g. 20 μs .

Hence 8/20 describes the form of the wave and 50 kA, for example, gives its peak value.

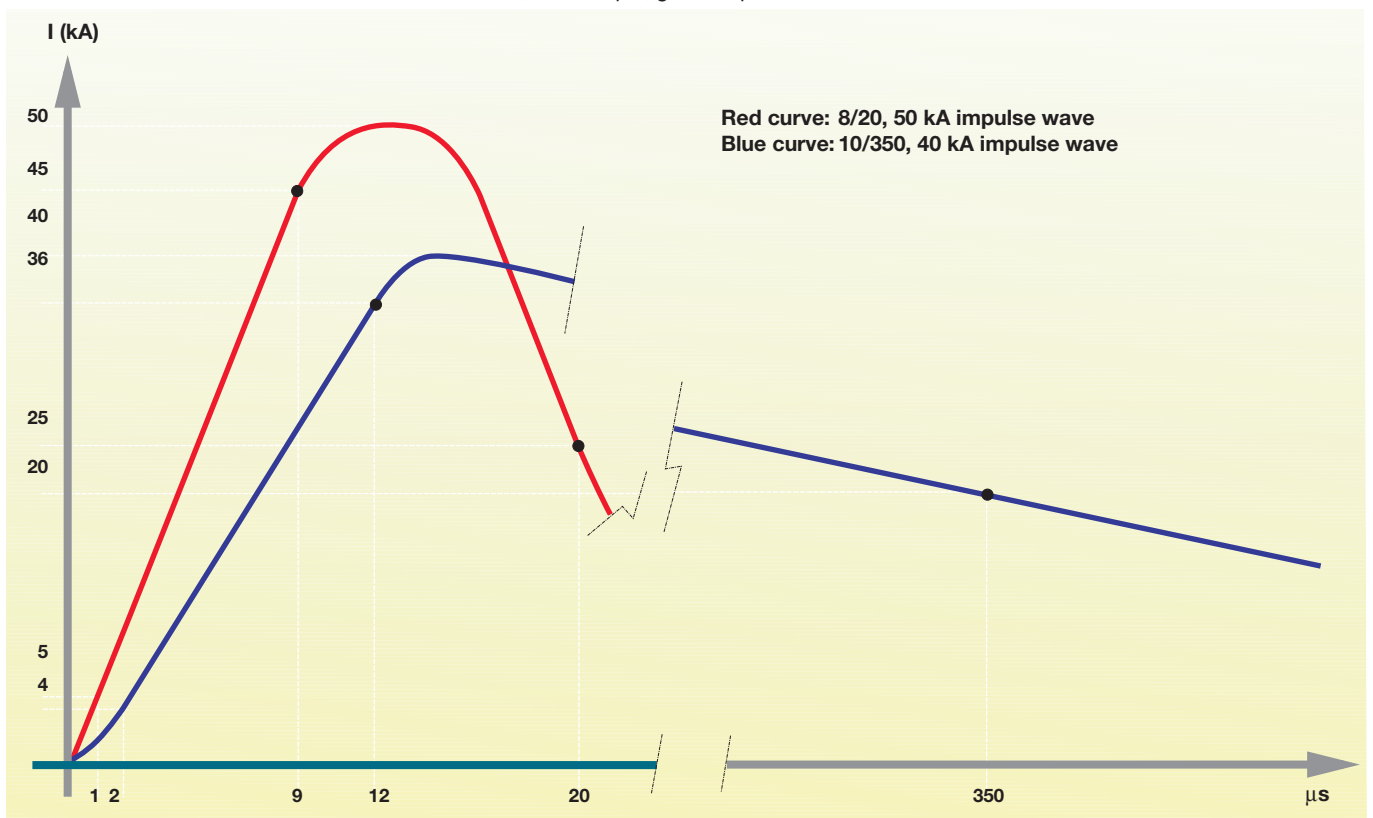

Simulation of current waveforms

General points

Earthing systems

The earthing system indicates the position of the protective conductor with respect to the neutral conductor. Installed devices must guarantee personnel protection and the protection of equipment.

There are 4 earthing systems differentiated by:

- the connection of the neutral with respect to earth;
- the connection of exposed conductive parts with respect to earth or the neutral.

Earthing system	Connection of neutral	Connection of exposed conductive parts
TT	Neutral connected to earth	Exposed conductive parts connected to an earth busbar
TN-C	Neutral connected to earth	Exposed conductive parts connected to the neutral
IT	Neutral isolated from earth or connected to earth via an impedance	Exposed conductive parts connected to an earth busbar
TN-S	Neutral connected to earth	Exposed conductive parts connected to the protective conductor

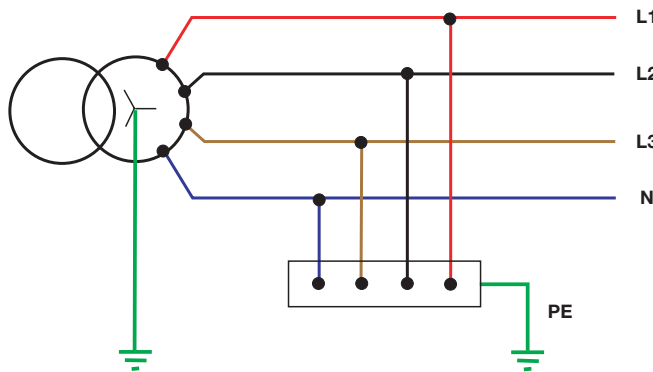

TT (neutral connected to earth) wiring diagram:

The neutral point of the supply is connected to earth. The exposed conductive parts of the installation are connected to an earth rod; either a separate earth rod or to the neutral earth rod.

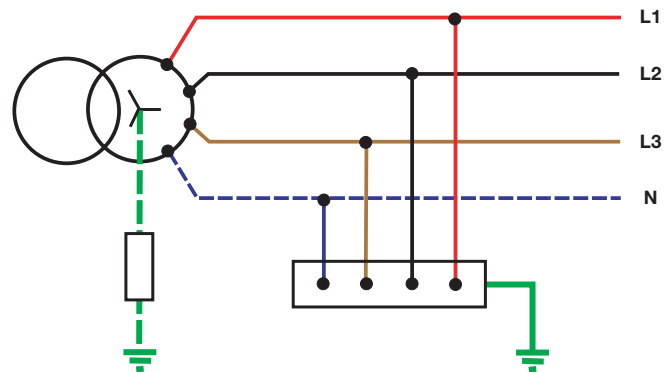

IT (neutral isolated or via impedance) wiring diagram:

The neutral point is either not connected to earth, or is so via an impedance (1000 to 2000 Ohms).

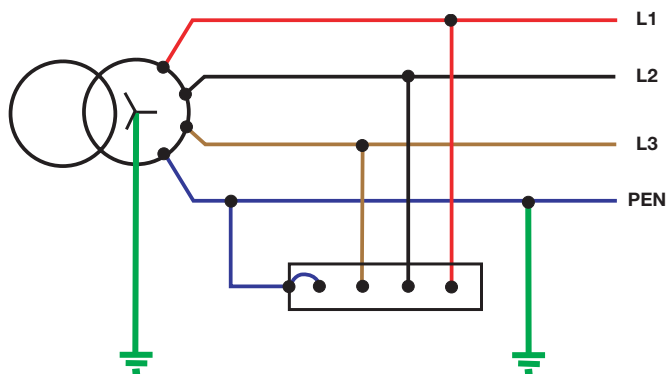

TN-C wiring diagram:

The neutral conductor and the protective conductor are the same conductor: PEN.

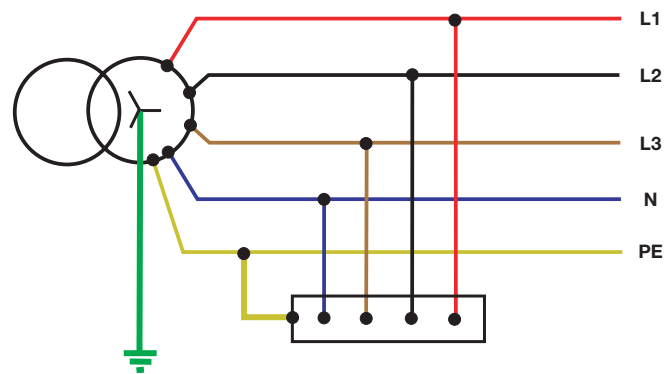

TN-S wiring diagram:

The neutral conductor and the protective conductor are separate.

General points

Earthing systems - Protection mode

Choice of earthing system

The choice of earthing system depends on:

- operating conditions,
- qualification of the maintenance team.

The earthing system may be imposed by the electricity supplier :

- TT for residential subscribers, small workshops and small tertiary installations,
- IT if continuity of service is required : hospitals, buildings open to the public.

YES	Continuity of service is the priority	NO
Isolated neutral (IT)		Isolated neutral (IT) Neutral connected to earth (TT) Distributed neutral (TN)
This is the surest to avoid breaks in the supply. E.g. use of priority safety circuits: high-rise buildings, hospitals.		Final choice after studying: <ul style="list-style-type: none"> • the installation's characteristics, • the complexity of implementing each type of earthing system, • the costs of each type of earthing system.

Earthing systems

Recommended	Type of installation
TT	Widespread network with poor earthing of exposed conductive parts
TN	Network located in a storm area
TT	Distribution network fed by overhead lines
IT	Emergency backup or peak period generator set
TN	Low insulation loads (ovens, kitchens, welding sets)
TT or TNS	Portable single-phase loads (drills, grinders)
TN	Handling machines, hoists, conveyer belts
TNS	Large number of auxiliaries, machine tools
IT or TT	Premises with fire risks
TT	Building sites (unreliable earth)
TNS	Electronic equipment, computers

Common mode and / or differential mode protection

Common mode

Common mode overvoltages appear between the live conductors and earth, e.g. phase/earth or neutral/earth.

A live conductor not only refers to the phase conductors but also to the neutral conductor.

This overvoltage mode destroys equipment connected to earth (class I equipment) and also equipment not connected to earth (class II equipment) which is located near an earthed mass and which does not have sufficient electrical isolation (a few kilovolts).

Class II equipment not located near an earthed mass is theoretically protected from this type of attack.

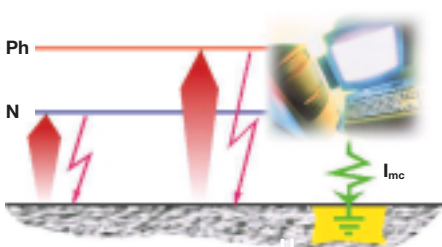

Note:
Common mode overvoltages affect all earthing systems.

Differential mode

Differential mode overvoltages circulate between live conductors: phase/phase or phase/neutral.

These overvoltages have a potentially high damaging effect for all equipment connected to the electrical network, especially 'sensitive' equipment.



Note:
Differential mode overvoltages affect the TT earthing system.
These overvoltages also affect the TN-S earthing system if there is a

considerable difference in the lengths of the neutral cable and the protective cable (PE).

General points

Protection mode

The overvoltage caused by a lightning strike inevitably generates differences in potential in common mode and can generate differences in potential in differential mode.

The solution consists of adopting combined "common" and "differential" modes; standard offer for ABB surge arresters.

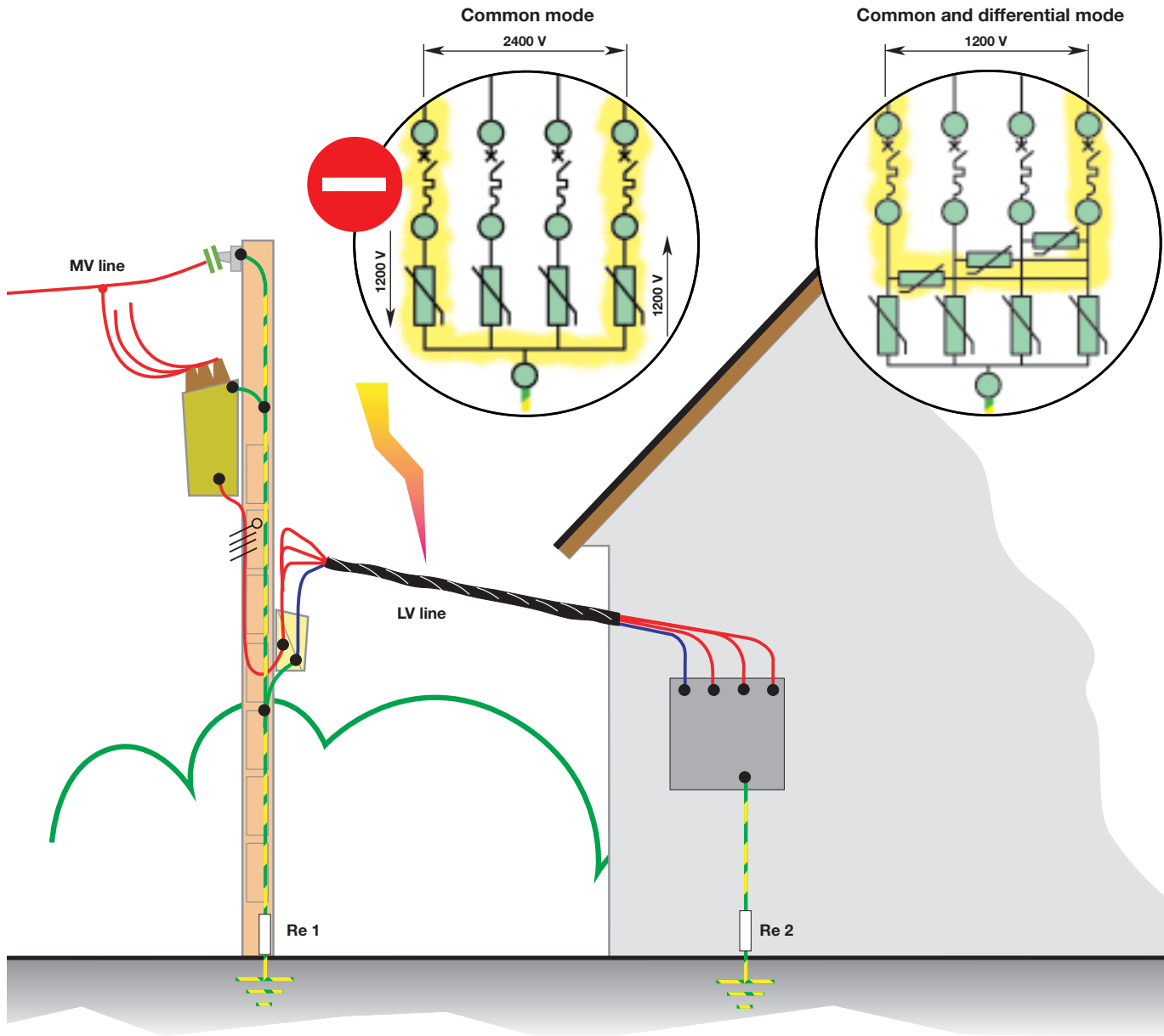

For $Re\ 1 < Re\ 2$

General points

Protection mode (for Type 2 MOV surge arresters)

Overvoltage protection in common and / or differential mode (MC / MD)

Non-linear components, amongst others, such as varistors and discharge tubes are used to stop overvoltages reaching equipment.

The combination of one or more of these components enables differential mode protection, common mode protection, or a combination of the two, depending on how they are wired.

Below are wiring diagrams or combinations according to the mode of protection.

Overvoltage protection in common mode (MC)

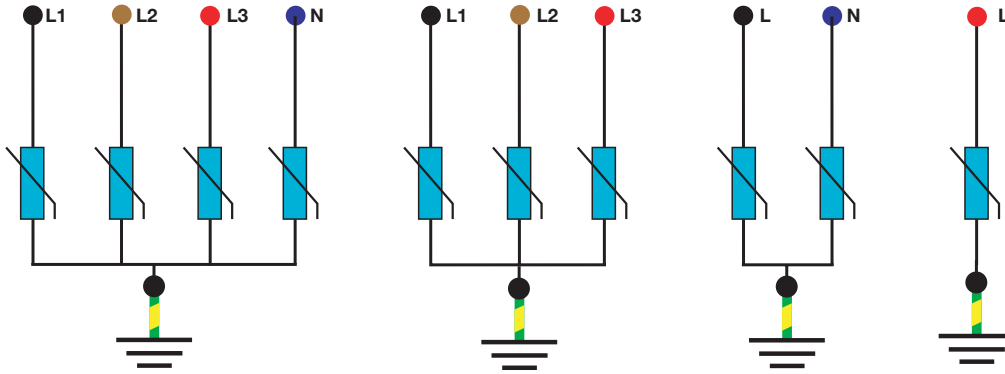

Overvoltage protection in differential mode (MD)

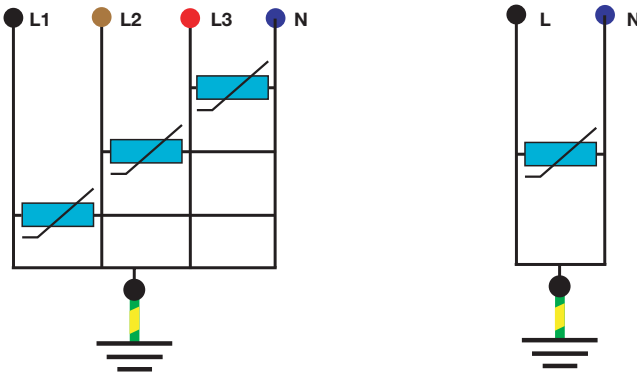

Overvoltage protection in common and differential mode (MC / MD)

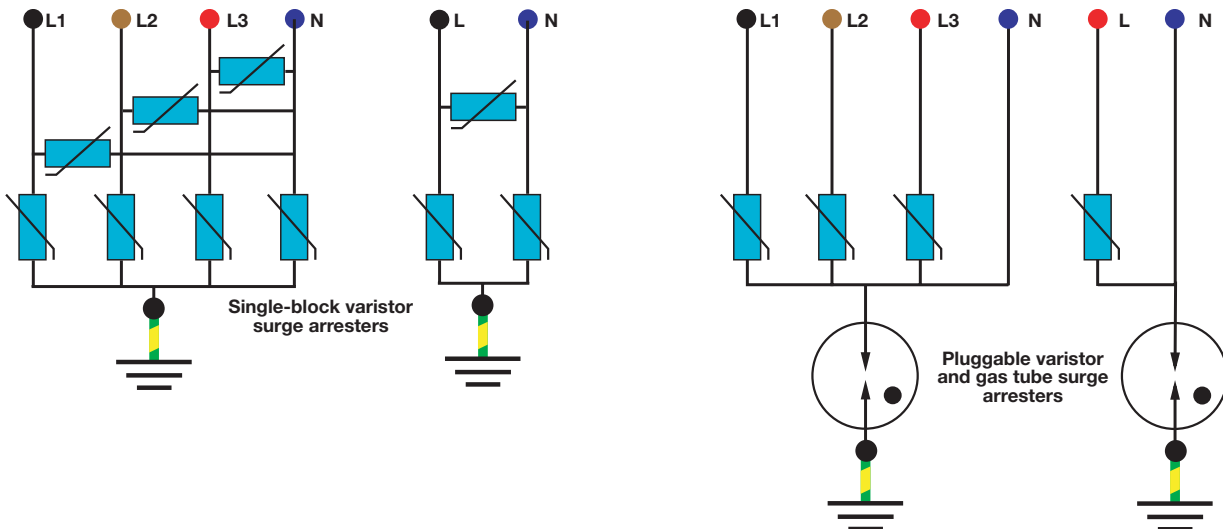

Selection

Choice of surge arrester

Choosing a surge arrester

The choice of surge arrester depends on a multitude of criteria defined when evaluating the lightning risk.

Evaluating the risk enables overvoltage protection requirements to be identified. When lightning protection is recommended, all that remains to be done is to select the appropriate product and install it.

All of the criteria that have to be taken into consideration make this risk analysis a laborious task which dissuades many people.

ABB's experience, expertise and precise study of standards related to this phenomenon have led us to develop a simplified procedure to optimise the choice and installation of overvoltage protection.

This work has resulted in a simplified and guided definition of surge arresters.

The choice of surge arrester is made according to several characteristics:







- The protection level (U_p).
- The maximum discharge capability: I_{imp} or I_{max} (10/350 or 8/20 impulse wave).
- The network's earthing system.
- The operating voltages (U_e , U_T).
- The options (end of life indicator, pluggable, Safety reserve, TS, Optical monitoring block).
- The short-circuit current (I_p) of a power supply in the installation.

When must we be protected?

This aspect includes requirements of standards and recommendations based upon ABB's expertise.

The criteria taken into consideration in this section are the evaluation of the risk of a direct lightning strike on or nearby the building, including the financial aspect caused by destruction or operating losses. Even if protection is not indispensable, it should be noted that since zero risk does not exist, a means of protection may always be useful.

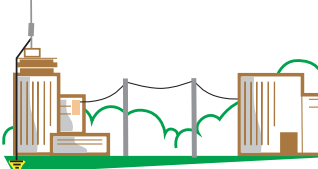
Environmental criteria

		
The building has a lightning conductor	$N_g > 2.5$ and overhead electricity lines	Building located on high land
Surge arrester obligatory	Surge arrester obligatory	Surge arrester recommended
Type 1	Type 1 or Type 2	Type 1 or Type 2 (65 kA)
		
Element over 20m high at less than 50 m from the building to be protected	Less than 500m in a direct line separate the lightning conductor and main electrical switchboard from the building to be protected	Less than 50 m of ground separate the lightning conductor from the building to be protected
Surge arrester recommended	Surge arrester recommended	Surge arrester recommended
Type 1 or Type 2	Type 1 or Type 2	Type 1 or Type 2 (65 kA)
Context	Context	Context
According to basic protection rules According to ABB installation rules	According to ABB installation rules	According to ABB installation rules
Type of surge arrester	Type of surge arrester	Type of surge arrester

Selection

Choosing the type of protection

Operational criteria

Recommended	Highly recommended	Very highly recommended	Selection criteria
●		●	<p>Continuity of supply is the priority (for reasons of operating loss costs, safety, etc.):</p> <ul style="list-style-type: none"> - factories, offices, banks, airports, police stations, chemists, video surveillance systems, etc., - hospitals, retirement homes, dialysis centres.
	●	●	<p>Equipment protection is the priority:</p> <ul style="list-style-type: none"> - high value > 150,000 Euros; - medium value > 15,000 Euros; - low value > 150 Euros.
	●	●	<p>Risk of lightning strikes in the region:</p> <ul style="list-style-type: none"> - $N_g \leq 2.5$ - $N_g > 2.5$ - isolated site.
●	●		<p>Type of electrical supply network feeding the site:</p> <ul style="list-style-type: none"> - overhead, - underground.

Note:

Repetitive overvoltages due to lightning strikes lead to economic losses that are much greater than the cost of installing surge arresters. The installation of surge arresters is a professional reflex when protecting medical equipment, in-line with the state of the art technology that is used.

To be kept in mind: the cost of the protection is low compared to the cost of the equipment to be protected.

Choosing the type of protection according to the network

Overvoltages are either common and differential mode or common mode only depending on the type of earthing system.

	TT	TN-S	TN-C	IT With N	IT Without N
Common mode	yes	yes	yes	yes	yes
Differential mode	yes	yes (1)	no	no	no

(1): If there is a considerable difference in the lengths of the neutral cable and the protective (PE) cable.

NOTE:

Suitable protection can be found for all network configurations in our modular power surge arresters.

Choice of U_c and U_T according to the nominal voltage (U_n) of the electrical network

The choice of operating voltage is also vital when selecting a surge arrester.

There are two voltage characteristics U_c and U_T .

The surge arresters in combination with their breaking devices must resist a temporary 50 Hz overvoltage without incurring any modification to their characteristics or functionalities. For a 230 V (phase-neutral) electrical network, this overvoltage is defined as follows:

U_T for 5 secs (+0 / -5 %).

U_T is given in the table below.

(e.g. $U_T = 400$ V with $U_o = 230$ V between phase and PE for a TT system).

It is imperative that these values are chosen in compliance with the table below according to the type of earthing system.

Surge arrester connection	Network earthing system according to IEC 60364-4-442									
	TT		TN-C		TN-S		IT (Neutral distributed)		IT (Neutral distributed)	
	U_c	U_T	U_c	U_T	U_c	U_T	U_c	U_T	U_c	U_T
Between Phase and Neutral	253 V	334 V	N.A.	N.A.	253 V	334 V	253	334 V	N.A.	N.A.
Between Phase and PE	253 V	400 V	N.A.	N.A.	253 V	334 V	400 V	N.A.	400 V	400 V
Between Neutral and PE	230 V	N.A.	N.A.	N.A.	230 V	N.A.	230 V	N.A.	N.A.	N.A.
Between Phase and PEN	N.A.	N.A.	253 V	334 V	N.A.	N.A.	N.A.	N.A.	N.A.	N.A.

(These voltages are minimum voltages) - N.A.: Not Applicable.

NOTE:

The table also gives U_c values which correspond to the maximum continuous voltage the surge arresters must be able to operate.

Selection

Choice of I_{imp} and I_{max} of the lightning current surge arrester

The run-off capacity of a surge arrester is determined by its electrical characteristics, and must be chosen according to the level of risk.

The choice of I_{imp} for Type 1 surge arrester in case of a 200 kA direct lightning strike (around 95% of strikes are less than 200 kA: IEC 61 024-1-1 Annex A, Basic values of lightning current parameters), is 25 kA for each power line.

I_{imp} for Type 1 surge arresters



ABB recommends a minimum I_{imp} of 25 kA for Type 1 surge arresters based on the following calculation :

- Prospective direct lightning strike current I: 200 kA (only 1% of discharges > 200 kA).
- Distribution of current within the building: 50 % to ground and 50 % to the electrical network (according to international standards IEC 61 643-12 Annex I-1-2).
- Equal distribution of the current in each of the conductors (3 L + N):

$$I_{imp} = \frac{100 \text{ kA}}{4} = 25 \text{ kA.}$$

I_{max} for Type 2 surge arresters

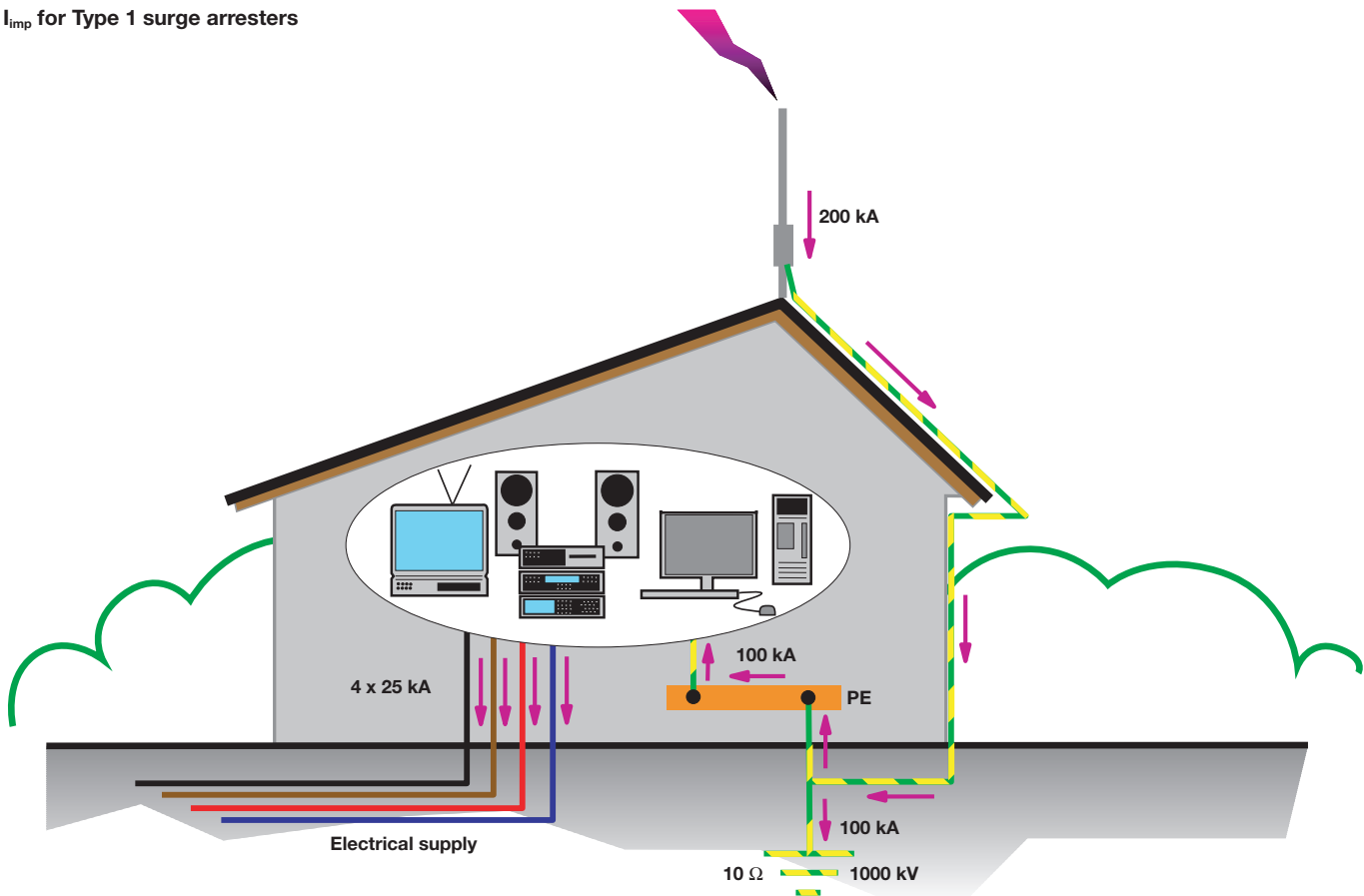
Optimisation of I_{max} for Type 2 surge arresters				
N_g	< 2	$2 \leq N_g < 3$	$3 \leq N_g < 4$	$4 < N_g$
I_n (kA)	5	15	20	30
I_{max} (kA)	15	40	65	100

NOTE:

ABB defines its Type 2 surge arresters according to their maximum current (I_{max}).

For a given I_{max} value, there is a corresponding nominal current value (I_n).

Selection

Principle of coordination

After having defined the characteristics of the incoming surge arrester, the protection must be completed with one or more additional surge arresters.

The incoming surge arrester does not provide effective protection for the whole installation by itself. Certain electrical phenomena can double the protection's residual voltage if cable lengths exceed 10m. Surge arresters must be coordinated when they are installed (refer to the tables below).

Coordination required if:

The incoming surge arrester does not reach the protection voltage (U_p) by itself.
The incoming surge arrester is more than 10m away from the equipment to be protected.

Recommended solution

Use of modular Type 2 surge arresters.

NOTE:

The coordination of Type 2 surge arresters is analysed using their respective maximum discharge currents I_{max} (8/20) starting from the installation's incoming switchboard and working towards the equipment which is to be protected, taking into account the progressive reduction in I_{max} .

E.g. 70 kA followed by 40 kA.

All ABB Type 2 surge arresters coordinate between each other by respecting a minimum distance of 1m between them.

Coordination between Type 1 and Type 2 surge arrester

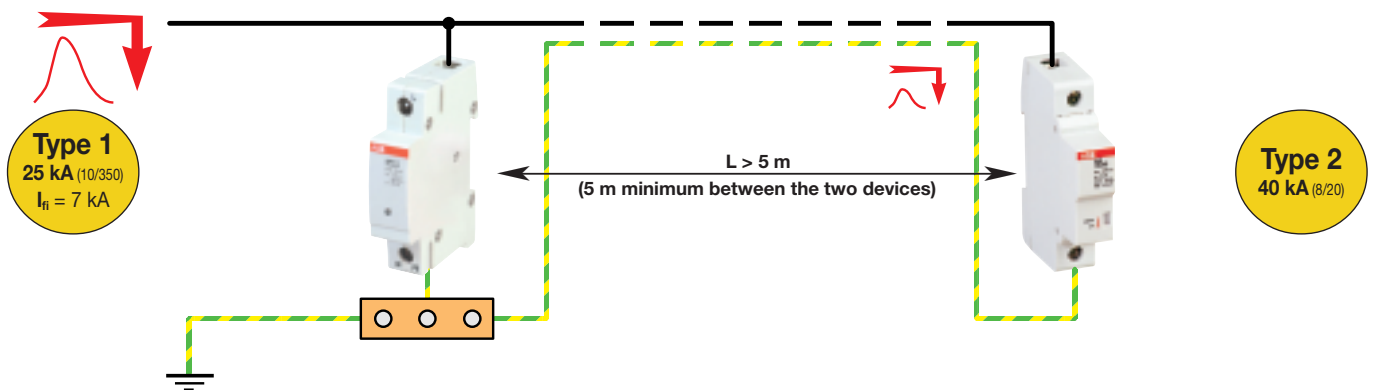
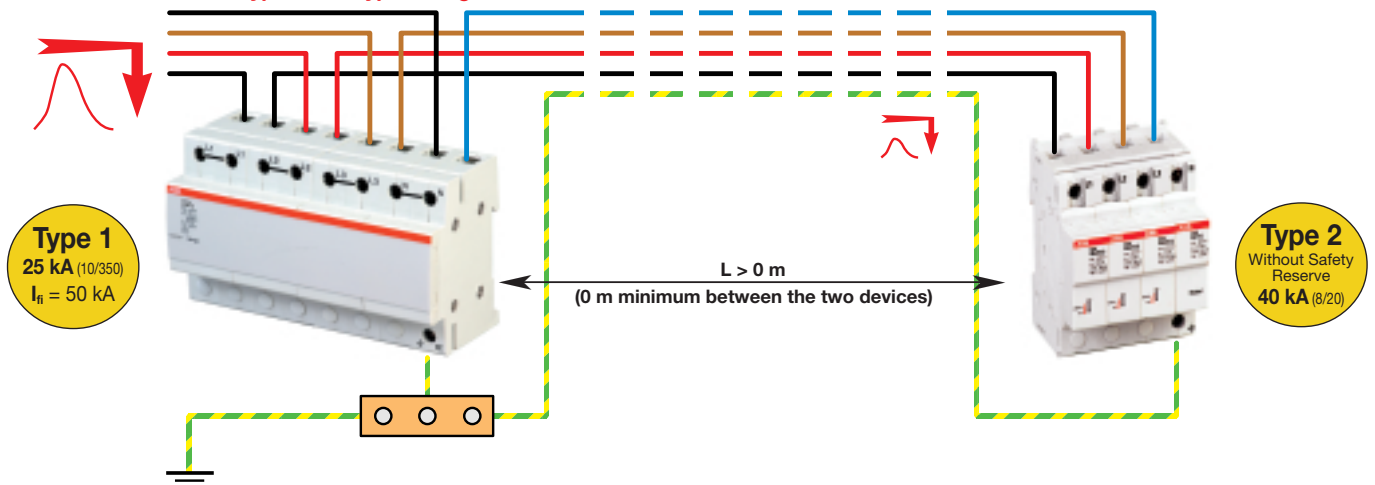

Coordination between Type 2 surge arresters

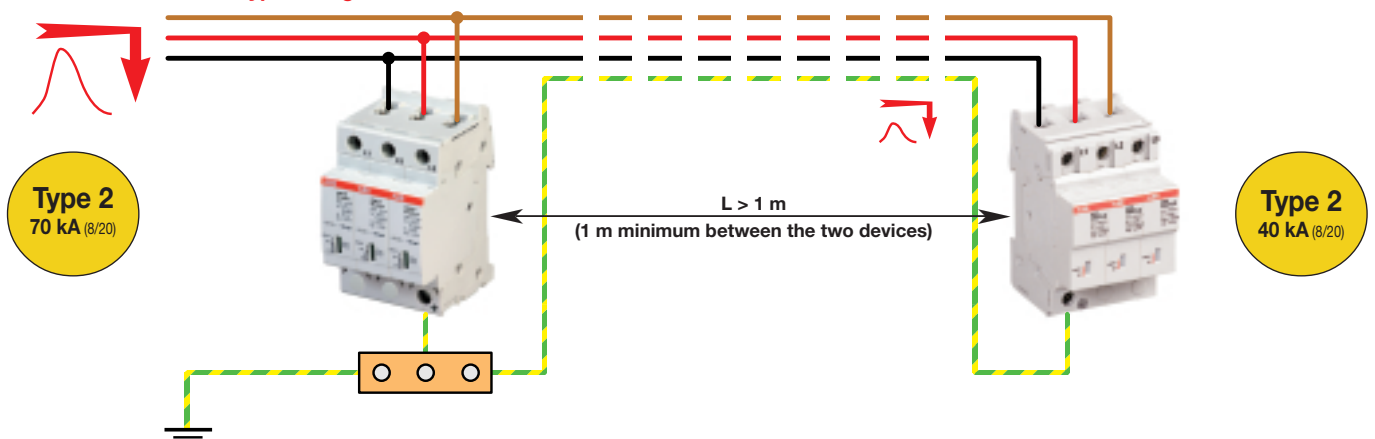

Selection

Options and advantages

End of life indicator of the surge arrester

This option enables indication of the surge arrester's state via a mechanical indicator which changes from white to red as the surge arrester comes to end-of-life. When this occurs, the surge arrester must be changed as protection is no longer guaranteed.

Safety Reserve (s) system

In case of current surge exceeding the maximum capacity of the device, the surge arrester will switch to the Safety reserve position and the remote indicator (TS) will switch to defect.

Consequently, the user is warned in advance and has more response time to replace the cartridge, because in Safety reserve position the protection is still ensured due to the 2-stage disconnecting system.

Pluggable

The pluggable feature of ABB surge arresters facilitates maintenance. Should one or more worn cartridges need to be replaced, the electrical circuit does not have to be isolated nor do the wires have to be removed.

Remote indication (TS)

This function, achieved by wiring a 3-point 1A volt-free contact, enables the operational state of the surge arrester to be checked remotely (maintenance premises). This can be global (several surge arresters) when an Optical Monitoring Block is used.

Technical features of the integrated auxiliary contact

- Contact complement: 1 NO (1 normally open contact), 1 NC (1 normally closed contact).
- Min. load: 12 V D.C. - 10 mA.
- Max. load: 250 V A.C. - 1 A.
- Connection cross-section: 1.5 mm².

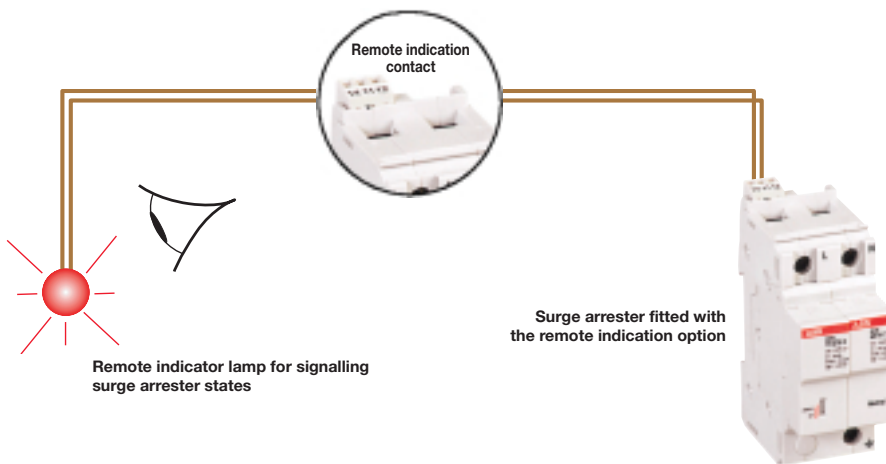

Optical Monitoring Block (OVR Sign)

This is made up of two elements, an emitter and a receiver, positioned at the extremities of the surge arrester row to be monitored.

Its optical barrier monitoring principle is compatible with all the power modular models and low current models (except OVR TC 200V).

This unit allows the operation of several DIN rail mounted surge arresters to be monitored simultaneously (10 modules of 17.5 mm).

In normal operation, the indicator lamps on the emitter and receiver are green.

In the event of surge arrester failure, the indicator lamp on the receiver turns red.

In the event of an optical monitoring block fuse fault, all the indicator lamps go out.

Global remote indication of the surge arrester row can be achieved by wiring the volt-free contact.

End-of-life indicator



Safety Reserve system



NOTE:

A faulty surge arrester does not interrupt continuity of service (if wired such that priority is given to continuity of service), it simply disconnects itself. But, the equipment is no longer protected.

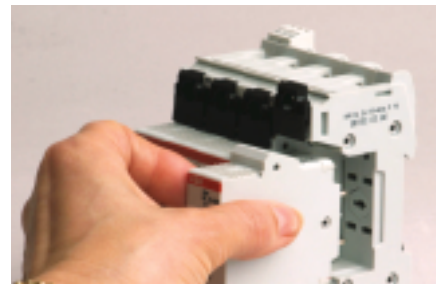

NOTE:

Pluggable surge arrester cartridges have a foolproof system (Neutral cartridges different to Phase cartridges) preventing incorrect operations when replacing a cartridge.

Optical Monitoring Block (OVR Sign)

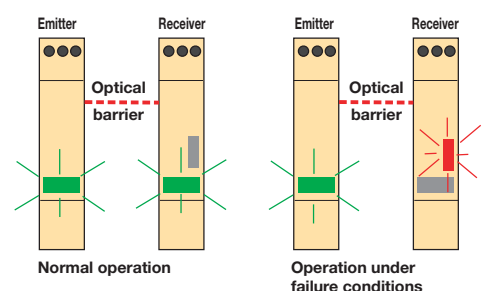

Selection

Example of a protected industrial installation

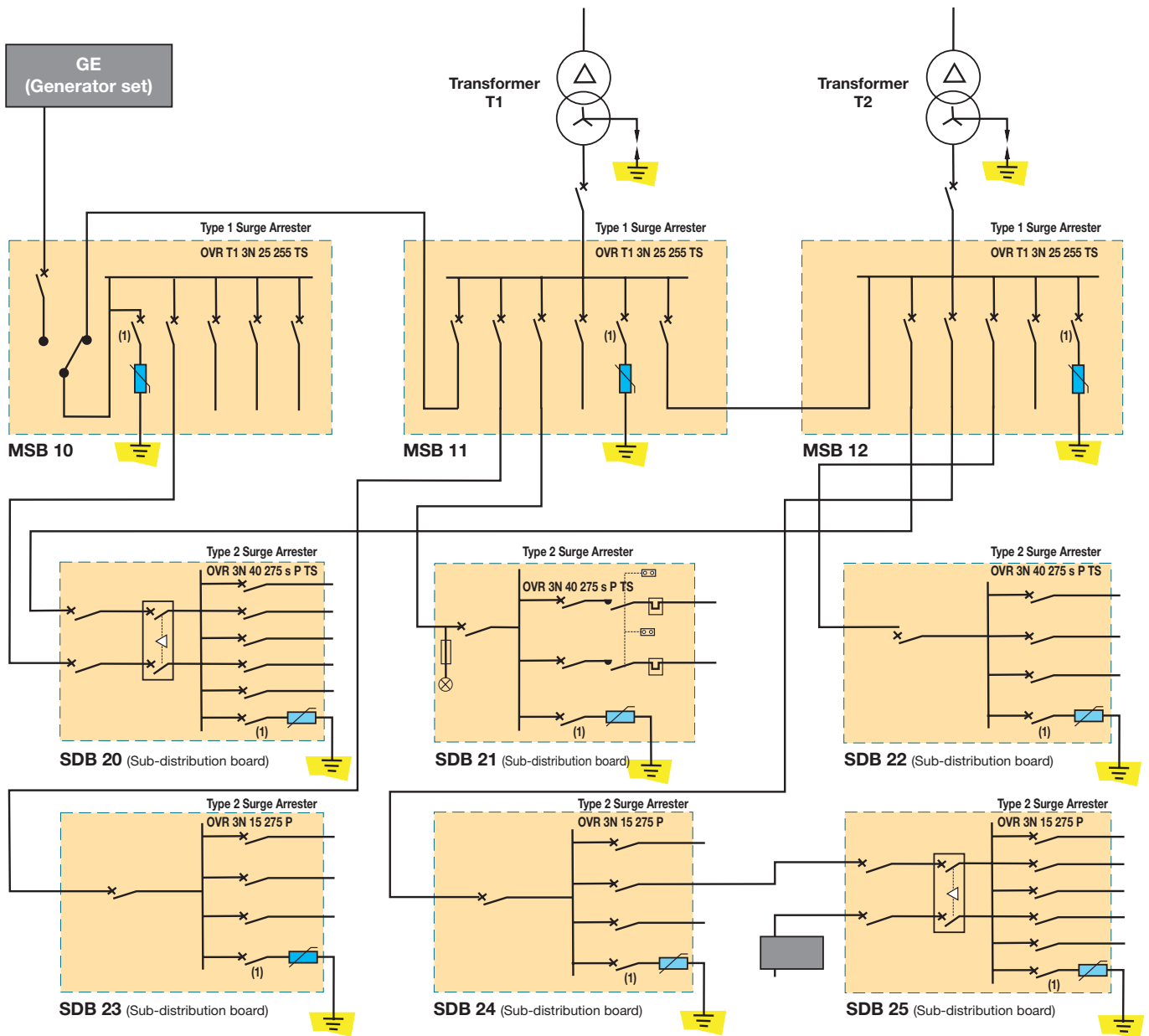

(1) The upstream circuit-breaker associated to each surge arrester must be an S 2 .. serie.

The above diagram is an example of an industrial application located in an area where the lightning strike density (N_g) is 1.2 lightning strikes per km^2 and per year:

- the building is protected by a lightning conductor.
- the lightning conductor's earthing strip is connected to the installation's earth network.
- the earthing system is IT (with distributed neutral) and then TNS for the sub-distribution boards.
- main switch boards (MSB) 10, 11 and 12 are fitted with Type 1 surge arresters OVR T1 3N 25 255 TS.
- sub-distribution boards (SDB) 20, 21 and 22 are fitted with Type 2 surge arresters OVR 3N 40 275 s P TS.
- sub-distribution boards (SDB) 23, 24 and 25 are fitted with Type 2 surge arresters OVR 3N 15 275 s P TS.

ABB Surge Protective Device range

Lightning current arresters (Spark gap) - Type 1



OVR T1 3L 25 255



OVR T1 3N 25 255 TS

Type 1 Surge Protective Devices are lightning current arresters: they are designed to discharge high energy from lightning impulse current while ensuring equipotential bonding in case of direct lightning strike on the installation.

Standards Info

Type 1 SPDs comply with IEC 61643-1.

Type 1 SPDs are recommended for locations having a high exposure to lightning, for example, line entrances to buildings protected by lightning rods or powered by aerial lines. These products are installed at the entrance of the installation (such as main distribution board).

The coordination of the Type 1 SPDs with the upstream fuse avoids nuisance tripping, for a better continuity of service.

The Type 1 SPD is immune to variations in the network voltage up to 400 V, thanks to its high TOV (Temporary Overvoltage) withstand.

Schematic diagrams

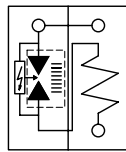

OVR T1 25 255

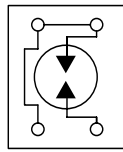

OVR T1 50 N
OVR T1 100 N

Fixing

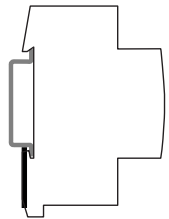

Simply clips onto DIN rail.



OVR T1 25 255-7

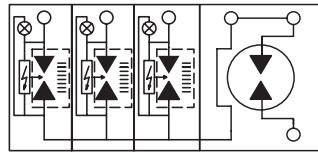

OVR T1 3N 25 255-7

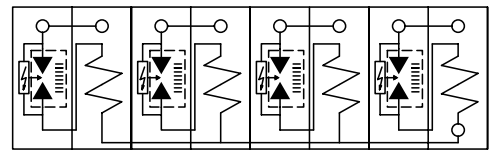

OVR T1 4L 25 255

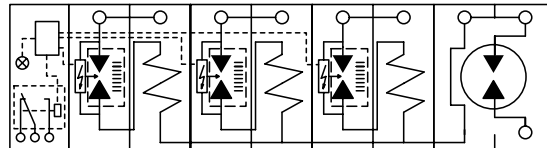

OVR T1 3N 25 255 TS

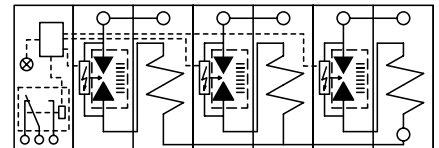

OVR T1 3L 25 255 TS

PRACTICAL INFO

Type 1 SPDs are installed at the entrance of the installation (such as main distribution board).

They provide either common mode or common and differential mode protection.

Dimensions

Dimensions	W (mm)	H (mm)	D (mm)
OVR T1 25 255-7	17.5	85	63
OVR T1 3N 25 255-7	87.5	85	63
OVR T1 25 255 / OVR T1 50 N / OVR T1 100 N	35	85	58
OVR T1 1N 25 255	70	85	58
OVR T1 3L 25 255	105	85	58
OVR T1 3N 25 255 / OVR T1 4L 25 255	140	85	58
OVR T1 1N 25 255 TS	87.5	85	58
OVR T1 3L 25 255 TS	122.5	85	58
OVR T1 3N 25 255 TS / OVR T1 4L 25 255 TS	157.5	85	58

Connection

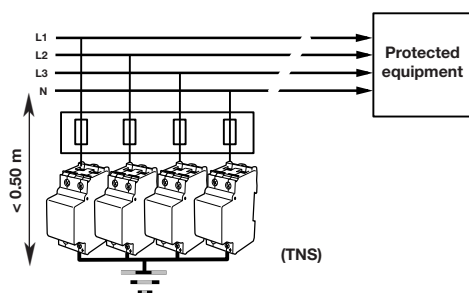

OVR T1 25 255

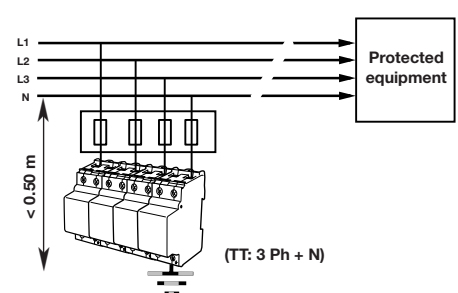

OVR T1 3N 25 255

ABB Surge Protective Device range

Lightning current arresters (Spark gap) - Characteristics

25 kA
(10/350)



Neutral
50 kA 100 kA
(10/350)

More info	OVR T1 25 255-7 (2CTB815101R8700)	OVR T1 3N 25 255-7 (2CTB815101R8800)	OVR T1 25 255 (2CTB815101R0100)	OVR T1 3L 25 255 (2CTB815101R1300)	OVR T1 3L 25 255 TS (2CTB815101R0600)	OVR T1 4L 25 255 (2CTB815101R1400)	OVR T1 4L 25 255 TS (2CTB815101R0800)	OVR T1 1N 25 255 (2CTB815101R1500)	OVR T1 1N 25 255 TS (2CTB815101R1000)	OVR T1 3N 25 255 (2CTB815101R1600)	OVR T1 3N 25 255 TS (2CTB815101R0700)	OVR T1 25 440-50 (2CTB815101R8300)	OVR T1 50 N (2CTB815101R0400)	OVR T1 100 N (2CTB815101R0500)
-----------	--------------------------------------	---	------------------------------------	---------------------------------------	--	---------------------------------------	--	---------------------------------------	--	---------------------------------------	--	---------------------------------------	----------------------------------	-----------------------------------

Electrical characteristics

	p.10	TNS-TNC-TT	TT	TNS-TNC-TT	TNC	TNC	TNS-TT	TNS-TT	TT	TT	TT	TNC-TNS-THT	TT	TT
Types of network														
Number of poles		1	4	1	3	3	4	4	2	4	4	1	1	1
Type of surge arrester		1	1	1	1	1	1	1	1	1	1	1	1	1
Type of current		A.C.	A.C.	A.C.	A.C.	A.C.	A.C.	A.C.	A.C.	A.C.	A.C.	A.C.	A.C.	A.C.
Nominal voltage: U_n	p. 7	230 V	230 V	230 V	230 V	230 V	230 V	230 V	230 V	230 V	230 V	400 V	-	-
Max. cont operating voltage: U_c	p. 8	255 V	255 V	255 V	255 V	255 V	255 V	255 V	255 V	255 V	255 V	440 V	255 V	255 V
Impulse current: I_{imp} (10/350 wave)	p. 7	25 kA	25/100 kA	25 kA	25/75 kA	25/75 kA	25/100 kA	25/100 kA	25/50 kA	25/50 kA	25/100 kA	25/100 kA	25 kA	50 kA 100 kA
Nominal discharge current:														
I_n (8/20 wave)	p. 7	25 kA	25 kA	25 kA	25 kA	25 kA	25 kA	25 kA	25 kA	25 kA	25 kA	25 kA	25 kA	50 kA 100 kA
Voltage protection level: U_p	p. 7	2.5 kV	2.5 kV	2.5 kV	2.5 kV	2.5 kV	2.5 kV	2.5 kV	2.5 / 1.5 kV	2.5 / 1.5 kV	2.5 / 1.5 kV	2.5 / 1.5 kV	2 kV	1.5 kV 1.5 kV
Follow current: I_f		7 kA	7 kA	50 kA	50 kA	50 kA	50 kA	50 kA	50 kA	50 kA	50 kA	50 kA	50 kA	0.1 kA 0.1 kA
TOV withstand: U_T (5 s.)		650 V	650 V	400 V	400 V	400 V	400 V	400 V	400 V	400 V	400 V	400 V	690 V	1200 V (200 ms)
Continuous operating current: I_c		< 1 mA	< 1 mA	< 0.2 mA	< 0.2 mA	< 10 mA	< 0.2 mA	< 10 mA	< 0.2 mA	< 10 mA	< 0.2 mA	< 10 mA	< 0.2 mA	< 0.2 mA
Short-circuit withstand capability: I_{sc}		50 kA	50 kA	50 kA	50 kA	50 kA	50 kA	50 kA	50 kA	50 kA	50 kA	50 kA	50 kA	N/A N/A
Response time: t_d		< 100 ns.	< 100 ns.	< 100 ns.	< 100 ns.	< 100 ns.	< 100 ns.	< 100 ns.	< 100 ns.	< 100 ns.	< 100 ns.	< 100 ns.	< 500 ns.	< 100 ns. < 100 ns.
Load current: I_{oad}		-	-	125 A	125 A	125 A	125 A	125 A	125 A	125 A	125 A	125 A	-	125 A 125 A
Max. back-up fuse: gG / gL	p. 45	125 A	125 A	125 A	125 A	125 A	125 A	125 A	125 A	125 A	125 A	125 A	125 A	125 A 125 A

Mechanical and installation characteristics

L/N/PE connection terminals:														
- solid wire		2.5 ... 50 mm ²												
- stranded wire		2.5 ... 35 mm ²												
L/N/PE stripping length		15												
L/N/PE tightening torque		3.5												
Indicator	p. 18	Yes	Yes	No	No	Yes	No	Yes	No	Yes	No	Yes	No	No No
Remote indicator (TS)	p. 18	No	No	No	No	Yes	No	Yes	No	Yes	No	Yes	No	No No

Miscellaneous characteristics

Degree of protection		IP 20												
Temperature range		-40 °C to +80 °C												
Maximum altitude		2000 m												
Case material		PA grey RAL 7035												
Insulating material		UL94 V0 classification												
Reference standards		IEC 61643-1 / EN 61643-11												
Weight		125 g	625 g	250 g	750 g	850 g	1000 g	1100 g	1000 g	1100 g	1000 g	1100 g	270 g	250 g 250 g

ABB Surge Protective Device range

Lightning current arresters (Spark gap/varistor) - Type 1+2



OVR HL 15 440 s P TS



OVR HL 2L 15 440 s P TS



OVR T1+2 25 255 TS

Type 1+2 surge arresters provide incoming protection for an installation which has a lightning conductor or which is located in a high lightning strike density area.

The high run-off capacity of Type 1+2 surge arresters (15 to 25 kA impulse current for 10/350 μ s waveform) enables them to resist very high energy transient overvoltages appearing on the electrical network (mains).

The absence of follow or holding current (I_f = None) means there will be no tripping of main breakers or blowing of fuses during normal operation of OVR HL ... SPDs.

Type 1+2 SPDs, provide low let through voltages (U_p) and allow easy coordination with OVR Type 2 SPDs (decoupling inductors not required when Types 1 & 2 SPDs are installed together).

Type 1+2 SPDs combine together Type 1 and Type 2 SPDs already coordinated. They can handle high energies from direct lightning strike and ensure a low voltage protection level to protect most of electrical and electronic equipment.

Standards Info

Type 1+2 surge arresters comply with IEC 61643-1.

Schematic diagrams

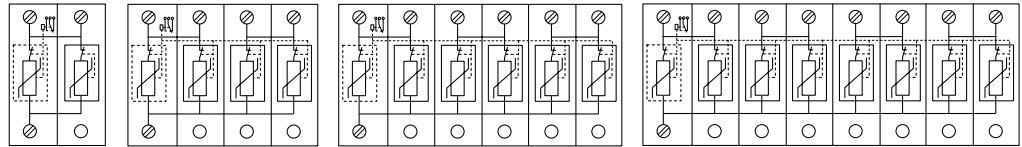

OVR HL

OVR HL 2L

OVR HL 3L

OVR HL 4L

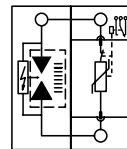

OVR T1+2 25 255 TS

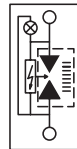

OVR T1+2 15 255-7

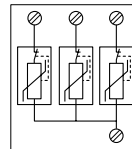

OVR T1+2 3L 7 275 s P

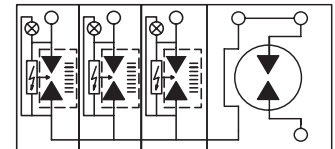

OVR T1+2 3N 15 255-7

Dimensions

Dimensions	W (mm)	H (mm)	D (mm)
OVR T1+2 7 275 s P	17.5	85	58
OVR T1+2 3L 7 275 s P	52.5	85	58
OVR T1+2 4L 7 275 s P	70	85	58
OVR T1+2 25 255 TS	35	85	63
OVR T1+2 15 255-7	17.5	85	58
OVR T1+2 3N 15 255-7	87.5	85	58
OVR HL 15 440 s P TS / OVR HL 15 255 s P TS	35	85	63
OVR HL 2L 15 440 s P TS	70	85	63
OVR HL 3L 15 440 s P TS	105	85	63
OVR HL 4L 15 440 s P TS	140	85	63

Fixing

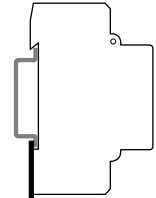

Simply clips onto DIN rail.

Connection

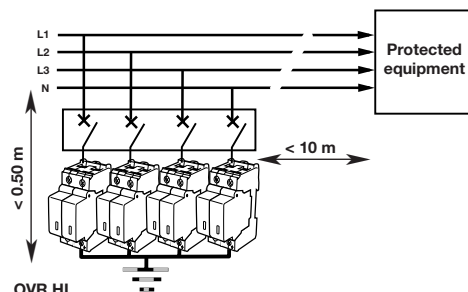

OVR HL

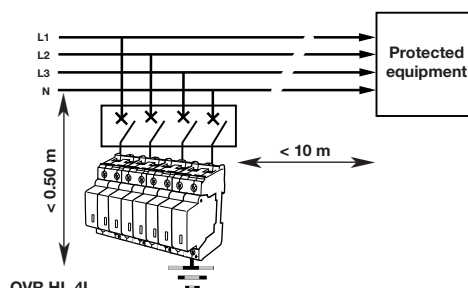

OVR HL 4L

Types of network

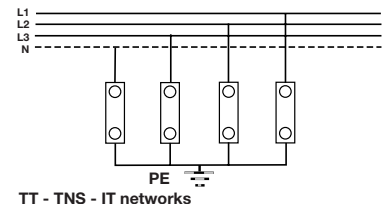

TT - TNS - IT networks

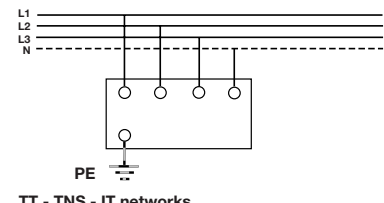

TT - TNS - IT networks

PRACTICAL INFO

Type 1+2 surge arresters are installed in main switchboards (MSBs) using DIN rail. They are used for common mode protection or common and differential mode protection.

ABB Surge Protective Device range

Lightning current arresters (Spark gap/varistor) - Characteristics

		7 kA (10/350)			15 kA (10/350)				25 kA (10/350)				
	More info	OVR T1+2 7 275 s P (2CTB815101R3900)	OVR T1+2 3L 7 275 s P (2CTB815101R4000)	OVR T1+2 4L 7 275 s P (2CTB815101R4100)	OVR T1+2 15 255-7 (2CTB815101R8900)	OVR T1+2 3N 15 255-7 (2CTB815101R9000)	OVR HL 15 440 s P TS (2CTB815201R0800)	OVR HL 15 255 s P TS (2CTB815201R0900)	OVR HL 2L 15 440 s P TS (2CTB815303R0400)	OVR HL 3L 15 440 s P TS (2CTB815401R0400)	OVR HL 4L 15 440 s P TS (2CTB815503R0400)	OVR T1+2 25 255 TS (2CTB815101R0300)	
Electrical characteristics													
Types of network	p.10	TNS-TNC-TT	TNC	TNS-TT	TNS-TNC-TT	TT	TNS-TNC-TT	TNS-TNC-TT	TNS-TT	TNC-TT	TNS-TT	TNS-TNC-TT	
Number of poles		1	3	4	1	4	1	1	2	3	4	1	
Type of surge arrester		1	1	1	1	1	1	1	1	1	1	1	
Type of current		A.C.	A.C.	A.C.	A.C.	A.C.	A.C.	A.C.	A.C.	A.C.	A.C.	A.C.	
Nominal voltage: U_n	p. 7	230 V	230 V	230 V	230 V	230 V	400 V	230 V	230/400 V	230/400 V	230/400 V	230 V	
Max cont operating voltage: U_c	p. 8	275 V	275 V	275 V	255 V	255 V	440 V	275 V	440 V	440 V	440 V	255 V	
Impulse current: I_{imp} (10/350 wave)	p. 7	7 kA	7 kA	7 kA	15 kA	15/50 kA	15 kA	15 kA	15 kA	15 kA	15 kA	25 kA	
Max. discharge current: I_{max} (8/20 wave)	p. 7	70 kA	70 kA	70 kA	-	-	100 kA	100 kA	100 kA	100 kA	100 kA	-	
Nominal discharge current: I_n (8/20 wave)	p. 7	6 kA	6 kA	6 kA	15 kA	15 kA	5 kA	5 kA	5 kA	5 kA	5 kA	25 kA	
Voltage protection level: U_p (at $I_n = 5$ kA)	p. 7	0.9 kV	0.9 kV	0.9 kV	1.5 kV	1.5 kV	1.4 kV	1.4 kV	1.4 kV	1.4 kV	1.4 kV	1.5 kV	
Residual voltage: U_{res} (at 3 kA)		0.85 kV	0.85 kV	0.85 kV	-	-	1.2 kV	1.2 kV	1.2 kV	1.2 kV	1.2 kV	1.2 kV	
Follow current: I_f		None	None	None	7 kA	7 kA	None	None	None	None	None	15 kA	
TOV withstand: U_T (5 s.)		334 V	334 V	334 V	650 V	650 V	440 V	440 V	440 V	440 V	440 V	334 V	
Continuous operating current: I_c		< 1 mA	< 1 mA	< 1 mA	< 0.2 mA	< 0.2 mA	< 1 mA	< 1 mA	< 1 mA	< 1 mA	< 1 mA	< 1 mA	
Short-circuit withstand capability: I_{sc}		50 kA	50 kA	50 kA	50 kA	50 kA	50 kA	50 kA	50 kA	50 kA	50 kA	50 kA	
Response time: t_d		≤ 25 ns	≤ 25 ns	≤ 25 ns	≤ 100 ns	≤ 100 ns	≤ 25 ns	≤ 25 ns	≤ 25 ns	≤ 25 ns	≤ 25 ns	≤ 25 ns	
Load current: I_{load}		-	-	-	-	-	-	-	-	-	-	125 A	
Associated breaking device:													
- gG - gL fuse	p. 45	20 A	20 A	20 A	125 A	125 A	25 A	25 A	25 A	25 A	25 A	125 A	
- curve C circuit-breaker	p. 45	32 A	32 A	32 A	-	-	40 A	40 A	40 A	40 A	40 A	-	
Mechanical and installation characteristics													
L/N connection terminals:													
- solid wire		2.5 ... 25 mm ²	2.5 ... 25 mm ²	2.5 ... 25 mm ²	2.5 ... 50 mm ²	2.5 ... 35 mm ²	2.5 ... 25 mm ²	2.5 ... 16 mm ²	2.5 ... 16 mm ²	2.5 ... 16 mm ²	2.5 ... 16 mm ²	2.5 ... 50 mm ²	
- stranded wire		2.5 ... 16 mm ²	2.5 ... 16 mm ²	2.5 ... 16 mm ²	2.5 ... 35 mm ²	2.5 ... 35 mm ²	2.5 ... 16 mm ²	2.5 ... 16 mm ²	2.5 ... 16 mm ²	2.5 ... 16 mm ²	2.5 ... 16 mm ²	2.5 ... 35 mm ²	
L/N stripping length		12.5 mm	12.5 mm	12.5 mm	15 mm	15 mm	12.5 mm	12.5 mm	12.5 mm	12.5 mm	12.5 mm	15 mm	
L/N tightening torque		2.8 Nm	2.8 Nm	2.8 Nm	3.5 Nm	3.5 Nm	2 Nm	2 Nm	2 Nm	2 Nm	2 Nm	3.5 Nm	
PE connection terminal:													
- solid wire		2.5 ... 25 mm ²	2.5 ... 25 mm ²	2.5 ... 25 mm ²	2.5 ... 50 mm ²	2.5 ... 35 mm ²	2.5 ... 25 mm ²	2.5 ... 16 mm ²	2.5 ... 16 mm ²	2.5 ... 16 mm ²	2.5 ... 16 mm ²	2.5 ... 50 mm ²	
- stranded wire		2.5 ... 16 mm ²	2.5 ... 16 mm ²	2.5 ... 16 mm ²	2.5 ... 35 mm ²	2.5 ... 35 mm ²	2.5 ... 16 mm ²	2.5 ... 16 mm ²	2.5 ... 16 mm ²	2.5 ... 16 mm ²	2.5 ... 16 mm ²	2.5 ... 35 mm ²	
PE stripping length		12.5 mm	12.5 mm	12.5 mm	15 mm	15 mm	12.5 mm	12.5 mm	12.5 mm	12.5 mm	12.5 mm	15 mm	
PE tightening torque		2.8 Nm	2.8 Nm	2.8 Nm	3.5 Nm	3.5 Nm	2 Nm	2 Nm	2 Nm	2 Nm	2 Nm	3.5 Nm	
Integrated thermal disconnecter		Yes	Yes	Yes	No	No	Yes	Yes	Yes	Yes	Yes	No	
End of life indicator	p. 18	Yes	Yes	Yes	Yes	Yes	Yes	Yes	Yes	Yes	Yes	Yes	
Compatibility with OVR Sign	p. 18	Yes	Yes	Yes	No	No	Yes	Yes	Yes	Yes	Yes	No	
Safety reserve (s)	p. 18	Yes	Yes	Yes	No	No	Yes	Yes	Yes	Yes	Yes	No	
Remote indicator (TS)	p. 18	No	No	No	No	No	Yes	Yes	Yes	Yes	Yes	Yes	
Miscellaneous characteristics													
Degree of protection		IP 20											
Temperature range		-40 °C to +80 °C											
Maximum altitude		2000 m											
Case material		PC grey RAL 7035			PA grey RAL 7035				PC grey RAL 7035				PA grey RAL 7035
Insulating material		UL94 V0 classification											
Reference standards		IEC 61643-1 / EN 61643-11											
Weight		150 g	450 g	600 g	125 g	500 g	250 g	250 g	500 g	750 g	1000 g	250 g	
Maintenance													
Replacement cartridges		OVR T1+2 7 275 s C (2CTB815501R3800)	3 x OVR T1+2 7 275 s C (2CTB815501R3800)	4 x OVR T1+2 7 275 s C (2CTB815501R3800)	-	-	OVR HL 15 440 s C (2CTB815250R0300)	OVR HL 15 255 s C (2CTB815250R0400)	2 x OVR HL 15 440 s C (2CTB815250R0300)	3 x OVR HL 15 440 s C (2CTB815250R0300)	4 x OVR HL 15 440 s C (2CTB815250R0300)	-	

ABB Surge Protective Device range

Single-block single-pole surge arresters (Varistor) - Type 2



OVR 15 440



OVR 100 440 s



OVR 40 275



OVR 65 275

The single-block single-pole modular power Type 2 surge arresters provide protection for equipment against transient overvoltages that occur on the electrical network (mains).

The maximum available discharge currents (I_{max}) range from 15 to 100 kA (8/20 μ s waveform).

Standards Info

The modular power Type 2 surge arresters comply with IEC 61643-1 and EN 61643-11.

The relevant standard for the installation of this type of surge arrester is: IEC 61643-12.

Schematic diagrams

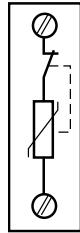

OVR 15 / 40 / 65 kA

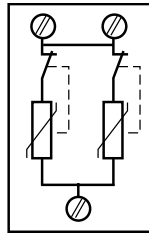

OVR 100 kA

Fixing

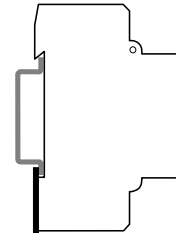

Simply clips onto DIN rail.

Dimensions

Dimensions	W (mm)	H (mm)	D (mm)
OVR 15 / 40 / 65 kA (all models)	17.5	85	63
OVR 100 kA	35	85	63

Connection

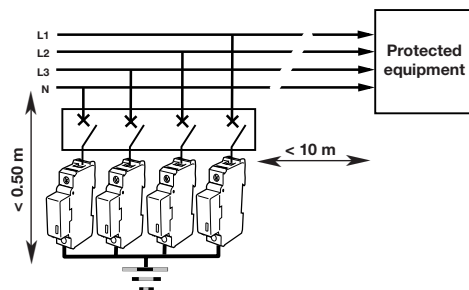

OVR 15 / 40 / 65 kA (all models)

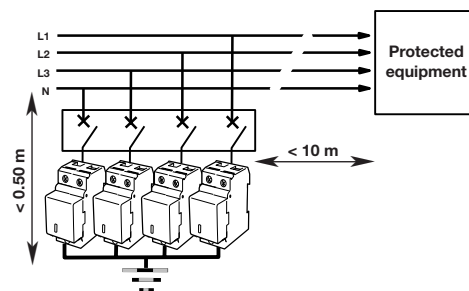

OVR 100 kA

Types of network

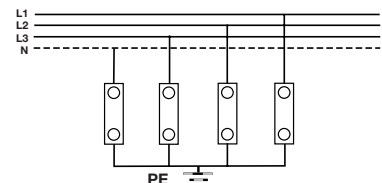

TT - TNS - IT networks

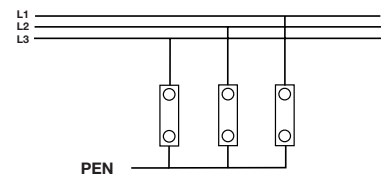

TNC networks

PRACTICAL INFO

Modular power Type 2 surge arresters are installed in main switchboards and in sub-distribution boards using DIN rail.

They are used for common mode protection.

ABB Surge Protective Device range

Single-block single-pole surge arresters (Varistor) - Characteristics

		15 kA (8/20)		40 kA (8/20)		65 kA (8/20)		100 kA (8/20)	
		275 V	440 V	275 V	440 V	275 V	440 V	275 V	440 V
More info		OVR 15 275 (2CTB813811R0800)	OVR 15 440 (2CTB813811R0400)	OVR 40 275 (2CTB813811R0700)	OVR 40 440 (2CTB813811R0300)	OVR 65 275 (2CTB813811R0600)	OVR 65 440 (2CTB813811R0200)	OVR 100 275 s (*) (2CTB813811R1200)	OVR 100 440 s (*) (2CTB813811R1100)
		OVR 40 275 s (*) (2CTB813811R1000)	OVR 40 440 s (*) (2CTB813811R0900)	OVR 65 275 s (*) (2CTB813811R0500)	OVR 65 440 s (*) (2CTB813811R0100)				
Electrical characteristics									
Types of network	p.10	TNC-TNS-TT	IT-TNC-TNS-TT	TNC-TNS-TT	IT-TNC-TNS-TT	TNC-TNS-TT	IT-TNC-TNS-TT	TNC-TNS-TT	IT-TNC-TNS-TT
Number of poles		1		1		1		1	
Type of surge arrester		2		2		2		2	
Type of current		A.C.		A.C.		A.C.		A.C.	
Nominal voltage: U_n	p. 7	230 V	400 V	230 V	400 V	230 V	400 V	230 V	400 V
Max. cont operating voltage: U_c	p. 8	275 V	440 V	275 V	440 V	275 V	440 V	275 V	440 V
Max. discharge current: I_{max} (8/20)	p. 7	15 kA		40 kA		65 kA		100 kA	
Nominal discharge current: I_n (8/20)	p. 7	5 kA		10 kA		20 kA		30 kA	
Voltage protection level: U_p at I_n	p. 7	1.2 kV	1.8 kV	1.2 kV	1.8 kV	1.2 kV	1.8 kV	1.2 kV	1.8 kV
Residual voltage: U_{res} at 3 kA		1.0 kV	1.5 kV	0.9 kV	1.4 kV	0.85 kV	1.3 kV	0.8 kV	1.25 kV
TOV withstand: U_T (5s)	p. 8	334 V	440 V	334 V	440 V	334 V	440 V	334 V	440 V
Continuous operating current: I_c		< 1 mA		< 1 mA		< 1 mA		< 1 mA	
Short-circuit withstand capability: I_s		10 kA		25 kA		25 kA		25 kA	
Response time: t_A		≤ 25 ns		≤ 25 ns		≤ 25 ns		≤ 25 ns	
Associated breaking device:									
- gG - gL fuse	p. 45	16 A		16 A		20 A		25 A	
- curve C circuit-breaker	p. 45	10 A		25 A		32 A		40 A	
Mechanical and installation characteristics									
L/N connection terminals:									
- solid wire		2.5 ... 25 mm ²							
- stranded wire		2.5 ... 16 mm ²							
L/N stripping length		12.5 mm							
L/N tightening torque		2 Nm							
PE connection terminal:									
- solid wire		2.5 ... 25 mm ²						2.5 ... 50 mm ²	
- stranded wire		2.5 ... 16 mm ²						2.5 ... 35 mm ²	
PE stripping length		12.5 mm						15 mm	
PE tightening torque		2 Nm						3.5 Nm	
Integrated thermal disconnecter		Yes						Yes	
End of life indicator	p. 18	Yes						Yes	
Compatibility with OVR Sign	p. 18	Yes						Yes	
Safety reserve (s)	p. 18	No		Yes (*)		Yes (*)		Yes (*)	
Remote indicator (TS)	p. 18	No		No		No		No	
Miscellaneous characteristics									
Degree of protection		IP 20							
Temperature range		-40 °C to +80 °C							
Maximum altitude		2000 m							
Case material		PC grey RAL 7035							
Insulating material		UL94 V0 classification							
Reference standards		IEC 61643-1 / EN 61643-11							
Weight		150 g						250 g	

ABB Surge Protective Device range

Single-block multi-pole surge arresters - Type 2



OVR 1N 15 275



OVR 4L 65 440 s

The single-block multi-pole modular power Type 2 surge arresters provide protection for equipment against transient overvoltages that occur on the electrical network (mains).

The maximum available discharge currents (I_{max}) range from 15 to 65 kA (8/20 μ s waveform). The range consist of 2 and 4-pole models.

Standards Info

The modular power Type 2 surge arresters comply with IEC 61643-1 and EN 61643-11.

The relevant standard for the installation of this type of surge arrester is: IEC 61643-12.

Schematic diagrams

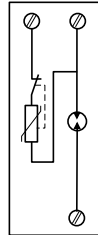

OVR 1N 10

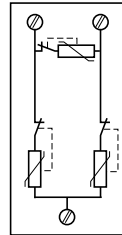

OVR 1N 15 / 40

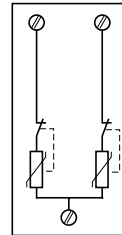

OVR 2L 65

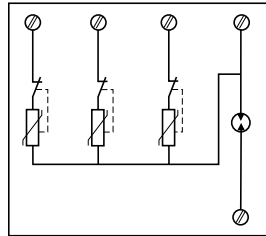

OVR 3N 10

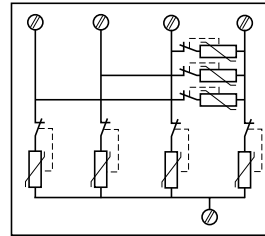

OVR 3N 15 / 40

Fixing

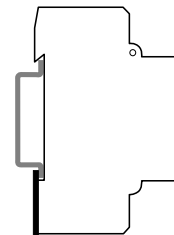

Simply clips onto DIN rail.

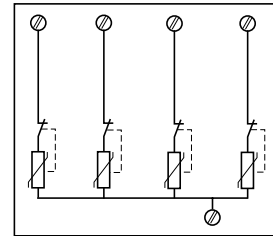

OVR 4L 65

Dimensions

Dimensions	W (mm)	H (mm)	D (mm)
OVR 1N	35	85	63
OVR 3N / 4L	70	85	63

Connection

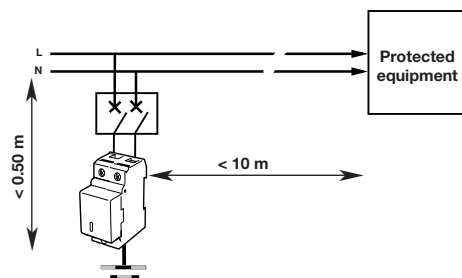

OVR 1N (all models)

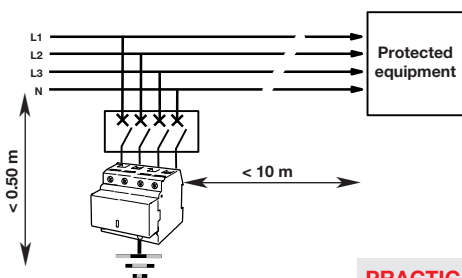

OVR 3N (all models)

Types of network

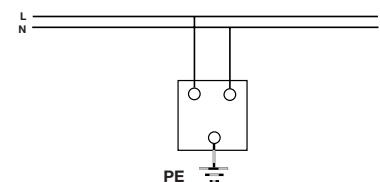

TT - TNS networks (2-pole models)

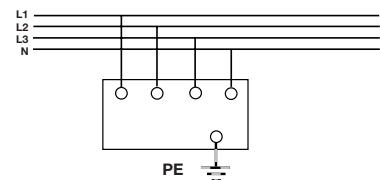

TT - TNS networks (4-pole models)

PRACTICAL INFO

Modular power Type 2 surge arresters are installed in sub-distribution boards using DIN rail. They provide common mode and differential mode protection (apart from OVR 2L / 4L 65 kA models, common mode only).

ABB Surge Protective Device range

Single-block multi-pole surge arresters - Characteristics

		10 kA (8/20)		15 kA (8/20)		40 kA (8/20)		65 kA (8/20)			
	More info	OVR 1N 10 275 (2CTB813912R1000)	OVR 3N 10 275 (2CTB813913R1000)	OVR 1N 15 275 (2CTB813912R0400)	OVR 3N 15 275 (2CTB813913R0400)	OVR 1N 40 275 (2CTB813912R0300)	OVR 3N 40 275 (2CTB813913R0300)	OVR 2L 65 440 (2CTB813912R0200)	OVR 2L 65 440 s (2CTB813912R0700)	OVR 4L 65 440 (2CTB813913R0200)	OVR 4L 65 440 s (2CTB813913R0700)
Electrical characteristics											
Types of network	p. 10	TNS-TT		TNS-TT-IT		TNS-TT-IT		IT-TNS-TT			
Number of poles		2	4	2	4	2	4	2		4	
Type of surge arrester		2		2		2		2			
Type of current		A.C.		A.C.		A.C.		A.C.			
Nominal voltage: U_n	p. 7	230 V		230 V		230 V		230 V			
Max cont operating voltage: U_c (L-N / N-PE)	p. 8	260 V		275 / 440 V		275 / 440 V		440 V (L-PE / N-PE)			
Max. discharge current: I_{max} (8/20)	p. 7	10 kA		15 kA		40 kA		65 kA			
Nominal discharge current: I_n (8/20)	p. 7	2 kA		5 kA		10 kA		20 kA			
Voltage protection level: U_p at I_n (L-N / N-PE)	p. 7	0.9 kV		1.2 / 1.8 kV		1.2 / 1.8 kV		1.8 kV (L-PE / N-PE)			
Residual voltage: U_{res} at 3 kA		-		1.0 / 1.5 kV		0.9 / 1.4 kV		1.3 kV (L-PE / N-PE)			
TOV withstand: U_T (5 s) (L-N / N-PE)	p. 8	334 / 440 V		334 / 440 V		334 / 440 V		440 V (L-PE / N-PE)			
Continuous operating current: I_c		< 1 mA		< 1 mA		< 1 mA		< 1 mA			
Short-circuit withstand capability: I_{sc}		10 kA		10 kA		25 kA		25 kA			
Response time: t_A		≤ 25 ns		≤ 25 ns		≤ 25 ns		≤ 25 ns			
Associated breaking device:											
- gG - gL fuse	p. 45	16 A		16 A		16 A		20 A			
- curve C circuit-breaker	p. 45	10 A		10 A		25 A		32 A			
Mechanical and installation characteristics											
L/N connection terminals:											
- solid wire		2.5 ... 25 mm ²									
- stranded wire		2.5 ... 16 mm ²									
L/N stripping length		12.5 mm									
L/N tightening torque		2 Nm									
PE connection terminal:											
- solid wire		2.5 ... 50 mm ²									
- stranded wire		2.5 ... 35 mm ²									
PE stripping length		15 mm									
PE tightening torque		3.5 Nm									
Integrated thermal disconnecter		Yes									
End of life indicator	p. 18	Yes									
Compatibility with OVR Sign	p. 18	Yes									
Safety reserve (s)	p. 18	No	No	No	No	No	No	No	Yes	No	Yes
Remote indicator (TS)	p. 18	No	No	No	No	No	No	No			
Miscellaneous characteristics											
Degree of protection		IP 20									
Temperature range		-40 °C to +80 °C									
Maximum altitude		2000 m									
Case material		PC grey RAL 7035									
Insulating material		UL94 V0 classification									
Reference standards		IEC 61643-1 / EN 61643-11									
Weight		200 g	400 g	200 g	400 g	200 g	400 g	200 g		400 g	

ABB Surge Protective Device range

Pluggable single-pole surge arresters - Type 2



OVR 15 440 P



OVR 100 440 s P TS



OVR 40 440 P TS

The pluggable single-pole modular power Type 2 surge arresters provide protection for equipment against transient overvoltages that occur on the electrical network (mains).

The maximum available discharge currents (I_{max}) range from 15 to 100 kA (8/20 μ s waveform).

Standards Info

The pluggable single-pole power Type 2 surge arresters comply with IEC 61643-1 and EN 61643-11.

The relevant standard for the installation of this type of surge arrester is: IEC 61643-12.

Schematic diagrams



OVR 15 / 40 / 70 P

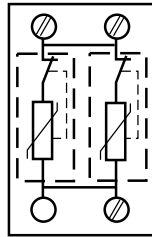

OVR 100 P

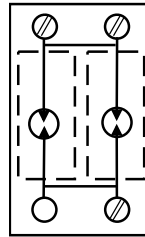

OVR 100 NP

Fixing

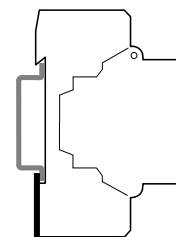

Simply clips onto DIN rail.

Dimensions

Dimensions	W (mm)	H (mm)	D (mm)
OVR 15 / 40 / 70 P (all models)	17.5	85	63
OVR 100 P	35	85	63

Connection

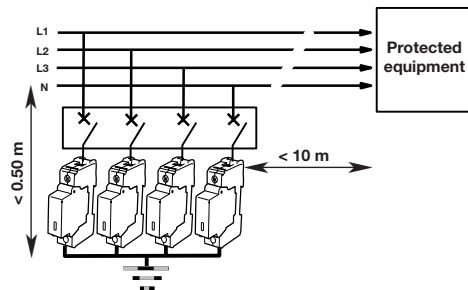

OVR 15 / 40 / 65 P

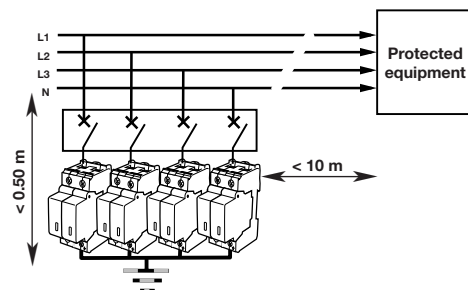

OVR 100 P (all models)

Types of network

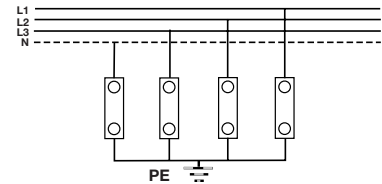

TT - TNS - IT networks (Single-pole all models)

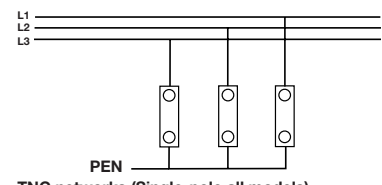

TNC networks (Single-pole all models)

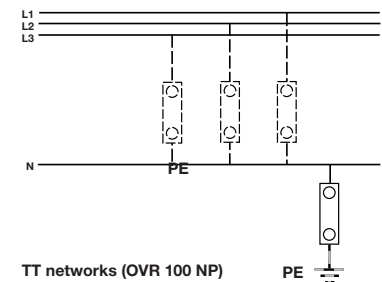

TT networks (OVR 100 NP)

PRACTICAL INFO

Pluggable single-pole surge arresters are installed in sub-distribution boards using DIN rail. They are used for common mode protection. Maintenance is made easier with pluggable surge arresters as replacement cartridges can be simply plugged-in without the need to isolate the circuit.

ABB Surge Protective Device range

Pluggable single-pole surge arresters - Characteristics

	15 kA (8/20)		40 kA (8/20)		70 kA (8/20)			100 kA (8/20)		
	275 V	440 V	275 V	440 V	275 V	440 V	Neutral	275 V	440 V	Neutral
More info	OVR 15 275 P (2CTB813851R2400)	OVR 15 440 P (2CTB813851R1200)	OVR 40 275 P (2CTB813851R2300)		OVR 70 275 P (2CTB813851R2200)	OVR 70 440 P (2CTB813851R1000)	OVR 70 NP (2CTB813851R0100)	OVR 100 275 P (2CTB813850R0400)		OVR 100 NP (2CTB813850R0300)
		OVR 15 440 P TS (*) (2CTB813851R0600)	OVR 40 275 s P (*) (2CTB813851R2000)		OVR 70 275 s P (*) (2CTB813851R1900)	OVR 70 440 s P (*) (2CTB813851R0700)		OVR 100 275 s P (*) (2CTB813850R0900)		
			OVR 40 275 P TS (*) (2CTB813851R1700)	OVR 40 440 P TS (*) (2CTB813851R0500)	OVR 70 275 P TS (*) (2CTB813851R1600)	OVR 70 440 P TS (*) (2CTB813851R0400)			OVR 100 440 s P (*) (2CTB813850R1200)	
			OVR 40 275 s P TS (*) (2CTB813851R1400)	OVR 40 440 s P TS (*) (2CTB813851R0200)	OVR 70 275 s P TS (*) (2CTB813851R1300)	OVR 70 440 s P TS (*) (2CTB813851R0100)		OVR 100 275 s P TS (*) (2CTB813850R0200)	OVR 100 440 s P TS (*) (2CTB813850R0100)	

Electrical characteristics

		TNC-TNS-TT	IT-TNC-TNS-TT	TNC-TNS-TT	IT-TNC-TNS-TT	TNC-TNS-TT	IT-TNC-TNS-TT	TT	TNC-TNS-TT	IT-TNC-TNS-TT	TT
Types of network	p.10										
Number of poles		1		1		1			1		
Type of surge arrester		2		2		2			2		
Type of current		A.C.		A.C.		A.C.			A.C.		
Nominal voltage: U_n	p. 7	230 V	400 V	230 V	400 V	230 V	400 V	-	230 V	400 V	-
Max. cont operating voltage: U_c	p. 8	275 V	440 V	275 V	440 V	275 V	440 V	255 V	275 V	440 V	255 V
Max. discharge current: I_{max}	p. 7	15 kA		40 kA		70 kA			100 kA		
Nominal discharge current: I_n	p. 7	5 kA		20 kA		30 kA			30 kA		
Voltage protection level: U_p at I_n	p. 7	1.0 kV	1.5 kV	1.4 kV	1.9kV	1.5 kV	2.0 kV	1.4 kV	1.2 kV	1.8kV	1.4 kV
Residual voltage: U_{res} at 3 kA		0.9 kV	1.4 kV	0.9 kV	1.4 kV	0.85 kV	1.3 kV	1.2 kV	0.8 kV	1.25 kV	1.2 kV
TOV withstand: U_T (5 s)	p. 8	334 V	440 V	334 V	440 V	334 V	440 V	1200 V (200ms)	334 V	440 V	1200 V (200ms)
Continuous operating current: I_c		< 1 mA		< 1 mA		< 1 mA			< 1 mA		
Short-circuit withstand capability: I_{sc}		50 kA		50 kA		50 kA			50 kA		
Response time: t_d		≤ 25 ns		≤ 25 ns		≤ 25 ns			≤ 100 ns		
Associated breaking device:											
- gG - gL fuse	p. 45	16 A		16 A		20 A			N/A		
- curve C circuit-breaker	p. 45	10 A		25 A		32 A			40 A		

Mechanical and installation characteristics

L/N connection terminals:											
- solid wire					2.5 ... 25 mm ²						
- stranded wire					2.5 ... 16 mm ²						
L/N stripping length					12.5 mm						
L/N tightening torque					2 Nm						
PE connection terminal:											
- solid wire					2.5 ... 25 mm ²						
- stranded wire					2.5 ... 16 mm ²						
PE stripping length					12.5 mm						
PE tightening torque					2 Nm						
Integrated thermal disconnecter					Yes						
End of life indicator	p. 18			Yes					No	Yes	No
Compatibility with OVR Sign	p. 18				Yes						
Safety reserve (s)	p. 18	No		Yes (*)		Yes (*)			No	Yes	No
Remote indicator (TS)	p. 18	No	Yes (*)	Yes (*)	Yes (*)	Yes (*)	No	No	Yes	No	

Miscellaneous characteristics

Degree of protection					IP 20						
Temperature range					-40 °C to +80 °C						
Maximum altitude					2000 m						
Case material					PC grey RAL 7035						
Insulating material					UL94 V0 classification						
Reference standards					IEC 61643-1 / EN 61643-11						
Weight					150 g			250 g			

Maintenance

Replacement cartridges		OVR 15 275 C (2CTB813854R1200)	OVR 15 440 C (2CTB813854R0600)	OVR 40 275 C (2CTB813854R1000)	OVR 40 440 C (2CTB813854R0400)	OVR 70 275 C (2CTB813854R0800)	OVR 70 440 C (2CTB813854R0200)	OVR 70 N C (2CTB813854R0000)			2 x OVR 70 N C (2CTB813854R0000)
				OVR 40 275 s C (*) (2CTB813854R0900)		OVR 70 275 s C (*) (2CTB813854R0700)	OVR 70 440 s C (*) (2CTB813854R0100)		2 x OVR 70 275 s C (*) (2CTB813854R0700)	2 x OVR 70 440 s C (*) (2CTB813854R0100)	

ABB Surge Protective Device range

Pluggable multi-pole surge arresters - Type 2



OVR 1N 40 275 P



OVR 1N 15 275 P TS

The maximum available discharge currents (I_{max}) range from 15 to 70 kA (8/20 μ s waveform).

The range consists of 2-pole models.

Standards Info

The pluggable multi-pole power Type 2 surge arresters comply with IEC 61643-1 and EN 61643-11.

The relevant standard for the installation of this type of surge arrester is: IEC 61643-12.

Schematic diagrams

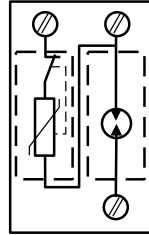

OVR 1N 15 / 40 / 70 P

Fixing

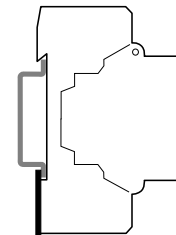

Simply clips onto DIN rail.

Dimensions

Dimensions	W (mm)	H (mm)	D (mm)
OVR 1N P (all models)	35	85	63

Connection

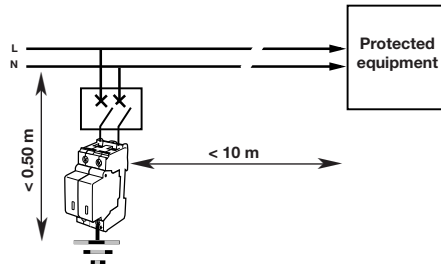

OVR 1N P (all models)

No marking for connection of OVR 2 15 75 s P TS (voltage Uno 70 V = max.)

Types of network

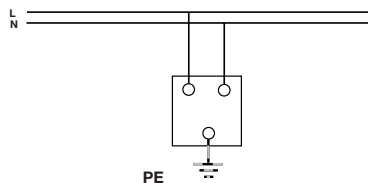

TT - TNS networks

PRACTICAL INFO

Pluggable multi-pole surge arresters are installed in sub-distribution boards using DIN rail. They are used for common and differential mode protection. Maintenance is made easier with pluggable surge arresters as replacement cartridges can be simply plugged-in without the need to isolate the circuit.

ABB Surge Protective Device range

Pluggable multi-pole surge arresters - Characteristics

		15 kA (8/20)		40 kA (8/20)				70 kA (8/20)			
	More info	OVR 1N 15 275 P (2CTB813952R1200)	OVR 1N 15 275 P TS (2CTB813952R0600)	OVR 1N 40 275 P (2CTB813952R1100)	OVR 1N 40 275 s P (°) (2CTB813952R0800)	OVR 1N 40 275 P TS (2CTB813952R0500)	OVR 1N 40 275 s P TS (°) (2CTB813952R0200)	OVR 1N 70 275 P (2CTB813952R1000)	OVR 1N 70 275 s P (°) (2CTB813952R0700)	OVR 1N 70 275 P TS (2CTB813952R0400)	OVR 1N 70 275 s P TS (°) (2CTB813952R0100)
Electrical characteristics											
Types of network	p.10	TNS-TT		TNS-TT				TNS-TT			
Number of poles		2		2				2			
Type of surge arrester		2		2				2			
Type of current		A.C.		A.C.				A.C.			
Nominal voltage: U _n	p. 7	230 V		230 V				230 V			
Max cont operating voltage: U _c (L-N / N-PE)	p. 8	275 / 255 V		275 / 255 V				275 / 255 V			
Maximum discharge current:											
I _{max} (8/20)	p. 7	15 kA		40 kA				70 kA			
Nominal discharge current: I _n (8/20)	p. 7	5 kA		20 kA				30 kA			
Voltage protection level:											
U _p at I _n (L-N / N-PE)	p. 7	1.0 / 1.4 kV		1.4 / 1.4 kV				1.5 / 1.4 kV			
Residual voltage: U _{res} at 3 kA		0.9 / 1.2 kV		0.9 / 1.2 kV				0.85 / 1.2 kV			
TOV withstand:											
U _T (L-N: 5 s / N-PE: 100 ms)	p. 8	334 / 1200 V		334 / 1200 V				334 / 1200 V			
Continuous operating current: I _c		< 1 mA		< 1 mA				< 1 mA			
Short-circuit withstand capability: I _{sc}		50 kA		50 kA				50 kA			
Response time: t _A		≤ 25 ns		≤ 25 ns				≤ 25 ns			
Associated breaking device:											
- gG - gL fuse	p. 45	16 A		16 A				20 A			
- curve C circuit-breaker	p. 45	10 A		25 A				32 A			
Mechanical and installation characteristics											
L/N connection terminals:											
- solid wire				2.5 ... 25 mm ²							
- stranded wire				2.5 ... 16 mm ²							
L/N stripping length				12.5 mm							
L/N tightening torque				2 Nm							
PE connection terminal:											
- solid wire				2.5 ... 25 mm ²							
- stranded wire				2.5 ... 16 mm ²							
PE stripping length				12.5 mm							
PE tightening torque				2 Nm							
Integrated thermal disconnecter				Yes							
End of life indicator	p. 18			Yes							
Compatibility with OVR Sign	p. 18			Yes							
Safety reserve (s)	p. 18	No	No	No	Yes	No	Yes	No	Yes	No	Yes
Remote indicator (TS)	p. 18	No	Yes	No	No	Yes	Yes	No	No	Yes	Yes
Miscellaneous characteristics											
Degree of protection				IP 20							
Temperature range				-40 °C to +80 °C							
Maximum altitude				2000 m							
Case material				PC grey RAL 7035							
Insulating material				UL94 V0 classification							
Reference standards				IEC 61643-1 / EN 61643-11							
Weight				200 g							
Maintenance											
Replacement cartridges		OVR 15 275 C (2CTB813854R1200)		OVR 40 275 C (2CTB813854R1000)				OVR 70 275 C (2CTB813854R0800)			
		+		+				+			
		OVR 70 N C (2CTB813854R0000)		OVR 70 N C (2CTB813854R0000)				OVR 70 N C (2CTB813854R0000)			
				OVR 40 275 s C (°) (2CTB813854R0900)				OVR 70 275 s C (°) (2CTB813854R0700)			
				+ OVR 70 N C (2CTB813854R0000)				+ OVR 70 N C (2CTB813854R0000)			

ABB Surge Protective Device range

Pluggable multi-pole surge arresters - Type 2



OVR 3N 15 275 P



OVR 3N 40 275 s P TS

The pluggable multi-pole modular power Type 2 surge arresters provide protection for equipment against transient overvoltages that occur on the electrical network (mains), whatever the cause: atmospheric (lightning), industrial (operating overvoltages) or from interference.

The maximum available discharge currents (I_{max}) range from 15 to 70 kA (8/20 μ s waveform).

The range consists of 4-pole models.

Standards Info

The pluggable multi-pole power Type 2 surge arresters comply with IEC 61643-1 and EN 61643-11.

The relevant standard for the installation of this type of surge arrester is: IEC 61643-12.

Schematic diagrams

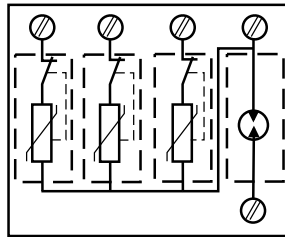

OVR 3N 15 / 40 / 70 P

Fixing

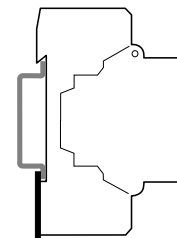

Simply clips onto DIN rail.

Dimensions

Dimensions	W (mm)	H (mm)	D (mm)
OVR 3N P (all models)	70	85	63

Connection

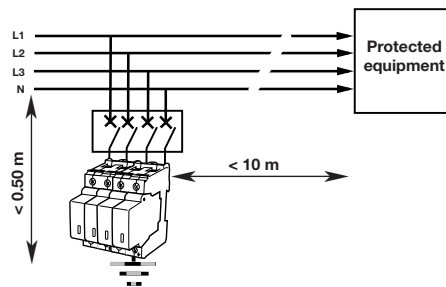

OVR 3N P (all models)

Types of network

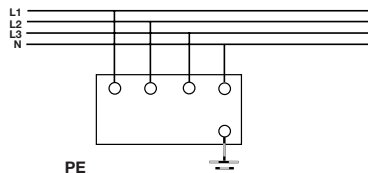

TT - TNS networks

PRACTICAL INFO

Pluggable multi-pole surge arresters are installed in sub-distribution boards using DIN rail. They are used for common and differential mode protection. Maintenance is made easier with pluggable surge arresters as replacement cartridges can be simply plugged-in without the need to isolate the circuit.

ABB Surge Protective Device range

Pluggable multi-pole surge arresters - Characteristics

	15 kA (8/20)		40 kA (8/20)		70 kA (8/20)	
	275 V	440 V	275 V	440 V	275 V	440 V
More info	OVR 3N 15 275 P (2CTB813953R1200) OVR 3N 15 275 P TS (**) (2CTB813953R0600)	OVR 3N 15 440 P (2CTB813953R6100)	OVR 3N 40 275 P (2CTB813953R1100) OVR 3N 40 275 s P (*) (2CTB813953R0800) OVR 3N 40 275 P TS (**) (2CTB813953R0500) OVR 3N 40 275 s P TS (**)(*) (2CTB813953R0200)	OVR 3N 40 440 P (2CTB813953R4100) OVR 3N 40 440 s P (*) (2CTB813953R6200) OVR 3N 40 440 P TS (**) (2CTB813953R4200) OVR 3N 40 440 s P TS (**)(*) (2CTB813953R1300)	OVR 3N 70 275 P (2CTB813953R1000) OVR 3N 70 275 s P (*) (2CTB813953R0700) OVR 3N 70 275 P TS (**) (2CTB813953R0400)	OVR 3N 70 440 s P (*) (2CTB813953R4300) OVR 3N 70 440 s P TS (**)(*) (2CTB813953R4400)

Electrical characteristics

		15 kA (8/20)		40 kA (8/20)		70 kA (8/20)	
Types of network	p.10	TNS-TT		TNS - TT		TNS - TT	
Number of poles		4		4		4	
Type of surge arrester		2		2		2	
Type of current		A.C.		A.C.		A.C.	
Nominal voltage: U _n	p. 7	230 V	400 V	230 V	400 V	230 V	400 V
Max. cont operating voltage:							
U _c (L-N/NPE)	p. 8	275 / 255 V	440 / 255 V	275 / 255 V	440 / 255 V	275 / 255 V	440 / 255 V
Max. discharge current: I _{max} (8/20)	p. 7	15 kA		40 kA		70 kA	
Nominal discharge current: I _n (8/20)	p. 7	5 kA		20 kA		30 kA	
Voltage protection level:							
U _p at I _n (L-N/N-PE)	p. 7	1.0 / 1.4 kV	1.5 / 1.4 kV	1.4 / 1.4 kV	1.9 / 1.4 kV	1.5 / 1.4 kV	2.0 / 1.4 kV
Residual voltage: U _{res} at 3 kA		0.9 / 1.2 kV	1.4 / 1.2 kV	0.9 / 1.2 kV	1.4 / 1.2 kV	0.85 / 1.2 kV	1.3 / 1.2 kV
TOV withstand:							
U _T (L-N: 5 s / N-PE: 200 ms)	p. 8	334 / 1200 V	440 / 1200 V	334 / 1200 V	440 / 1200 V	334 / 1200 V	440 / 1200 V
Continuous operating current: I _c		< 1 mA		< 1 mA		< 1 mA	
Short-circuit withstand capability: I _{sc}		50 kA		50 kA		50 kA	
Response time: t _A		≤ 25 ns		≤ 25 ns		≤ 25 ns	
Associated breaking device:							
- gG - gL fuse	p. 45	16 A		16 A		20 A	
- curve C circuit-breaker	p. 45	10 A		25 A		32 A	

Mechanical and installation characteristics

L/N connection terminals:							
- solid wire				2.5 ... 25 mm ²			
- stranded wire				2.5 ... 16 mm ²			
L/N stripping length				12.5 mm			
L/N tightening torque				2 Nm			
PE connection terminal:							
- solid wire				2.5 ... 25 mm ²			
- stranded wire				2.5 ... 16 mm ²			
PE stripping length				12.5 mm			
PE tightening torque				2 Nm			
Integrated thermal disconnecter				Yes			
End of life indicator	p. 18			Yes			
Compatibility with OVR Sign	p. 18			Yes			
Safety reserve (s)	p. 18	No	No	Yes (*)	Yes (*)	Yes (*)	Yes (*)
Remote indicator (TS)	p. 18	Yes (*)	No	Yes (*)	Yes (*)	Yes (*)	Yes (*)

Miscellaneous characteristics

Degree of protection				IP 20			
Temperature range				-40 °C to +80 °C			
Maximum altitude				2000 m			
Case material				PC grey RAL 7035			
Insulating material				UL94 V0 classification			
Reference standards				IEC 61643-1 / EN 61643-11			
Weight				400 g			

Maintenance

Replacement cartridges		3 x OVR 15 275 C (2CTB813854R1200)	3 x OVR 15 440 C (2CTB813854R0600)	3 x OVR 40 275 C (2CTB813854R1000)	3 x OVR 70 275 C (2CTB813854R0800)	3 x OVR 70 440 s C (*) (2CTB813854R0100)
		+	+	+	+	+
		OVR 70 N C (2CTB813854R0000)	OVR 70 N C (2CTB813854R0000)	OVR 70 N C (2CTB813854R0000)	OVR 70 N C (2CTB813854R0000)	OVR 70 N C (2CTB813854R0000)
				3 x OVR 40 275 s C (*) (2CTB813854R0900)	3 x OVR 70 275 s C (*) (2CTB813854R0700)	
				+	+	
				OVR 70 N C (2CTB813854R0000)	OVR 70 N C (2CTB813854R0000)	

ABB Surge Protective Device range

Pluggable multi-pole surge arresters - Type 2



OVR 3L 40 440 s P TS

The pluggable multi-pole modular power Type 2 surge arresters provide protection for equipment against transient overvoltages that occur on the electrical network (mains), whatever the cause: atmospheric (lightning), industrial (operating overvoltages) or from interference.

The maximum available discharge currents (I_{max}) range from 15 to 70 kA (8/20 μ s waveform).

The range consists of 3-pole models.

Standards Info

The pluggable multi-pole power Type 2 surge arresters comply with IEC 61643-1 and EN 61643-11.

The relevant standard for the installation of this type of surge arrester is: IEC 61643-12.

Schematic diagrams

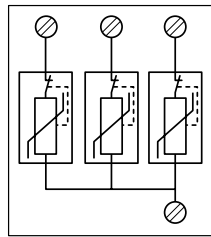

OVR 3L 15 / 40 / 70 P

Fixing

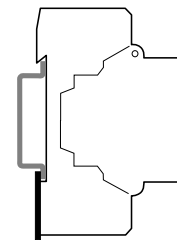

Simply clips onto DIN rail.

Dimensions

Dimensions	W (mm)	H (mm)	D (mm)
OVR 3L P (all models)	52.5	85	63

Connection

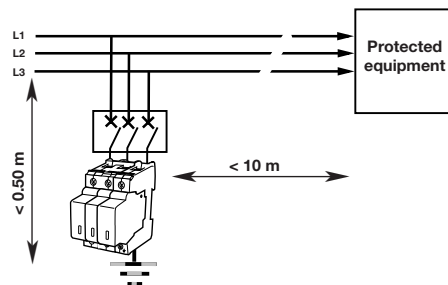

OVR 3L P (all models)

Types of network

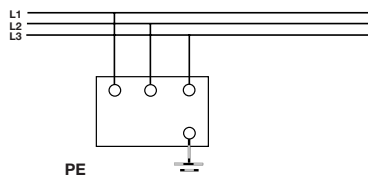

TNC networks

PRACTICAL INFO

Pluggable multi-pole surge arresters are installed in sub-distribution boards using DIN rail. They are used for common mode protection.

Maintenance is made easier with pluggable surge arresters as replacement cartridges can be simply plugged-in without the need to isolate the circuit.

ABB Surge Protective Device range

Pluggable multi-pole surge arresters - Characteristics

	More info	15 kA (8/20)		40 kA (8/20)		70 kA (8/20)	
		275 V	440 V	275 V	440 V	275 V	
		OVR 3L 15 275 s P (2CTB813853R3400)	OVR 3L 15 440 P (2CTB813853R3000)	OVR 3L 40 275 P (2CTB813853R2400)	OVR 3L 40 440 P (2CTB813853R2800)	OVR 3L 70 275 P (2CTB813853R4200)	
			OVR 3L 15 440 P TS (**) (2CTB813853R3200)	OVR 3L 40 275 s P (*) (2CTB813853R2200)	OVR 3L 40 440 s P (*) (2CTB813853R2600)	OVR 3L 70 275 s P (*) (2CTB813853R4100)	
		OVR 3L 15 275 s P TS (**) (2CTB813853R3500)		OVR 3L 40 275 P TS (**) (2CTB813853R2500)	OVR 3L 40 440 P TS (**) (2CTB813853R2900)	OVR 3L 70 275 P TS (**) (2CTB813853R4300)	
				OVR 3L 40 275 s P TS (*) (**) (2CTB813853R2300)	OVR 3L 40 440 s P TS (*) (**) (2CTB813853R2700)	OVR 3L 70 275 s P TS (*) (**) (2CTB813853R4400)	

Electrical characteristics

	p.10	TNC	TNC-IT	TNC	TNC-IT	TNC
Types of network						
Number of poles			3		3	3
Type of surge arrester			2		2	2
Type of current			A.C.		A.C.	A.C.
Nominal voltage: U_n	p. 7	230 V	400 V	230 V	400 V	230 V
Max. cont operating voltage: U_c	p. 8	275 V	440 V	275 V	440 V	275 V
Max. discharge current: I_{max} (8/20)	p. 7		15 kA		40 kA	70 kA
Nominal discharge current: I_n (8/20)	p. 7		5 kA		20 kA	30 kA
Voltage protection level: U_p at I_n	p. 7	1.0 kV	1.5 kV	1.4 kV	1.9 kV	1.5 kV
Residual voltage: U_{res} at 3 kA		0.9 kV	1.4 kV	0.9 kV	1.4 kV	0.85 kV
TOV withstand: U_T (5 s.)	p. 8	334 V	440 V	334 V	440 V	334 V
Continuous operating current: I_c			< 1 mA		< 1 mA	< 1 mA
Short-circuit withstand capability: I_{sc}			50 kA		50 kA	50 kA
Response time: t_A			≤ 25 ns		≤ 25 ns	≤ 25 ns
Associated breaking device:						
- gG - gL fuse	p. 45		16 A		16 A	20 A
- curve C circuit-breaker	p. 45		10 A		25 A	32 A

Mechanical and installation characteristics

L/N connection terminals:						
- solid wire					2.5 ... 25 mm ²	
- stranded wire					2.5 ... 16 mm ²	
L/N stripping length					12.5 mm	
L/N tightening torque					2 Nm	
PE connection terminal:						
- solid wire					2.5 ... 25 mm ²	
- stranded wire					2.5 ... 16 mm ²	
PE stripping length					12.5 mm	
PE tightening torque					2 Nm	
Integrated thermal disconnecter					Yes	
End of life indicator	p. 18				Yes	
Compatibility with OVR Sign	p. 18				Yes	
Safety reserve (s)	p. 18	Yes	No	Yes (*)	Yes (*)	Yes (*)
Remote indicator (TS)	p. 18	Yes (**)	Yes (**)	Yes (**)	Yes (**)	Yes (**)

Miscellaneous characteristics

Degree of protection					IP 20	
Temperature range					-40 °C to +80 °C	
Maximum altitude					2000 m	
Case material					PC grey RAL 7035	
Insulating material					UL94 V0 classification	
Reference standards					IEC 61643-1 / EN 61643-11	
Weight					300 g	

Maintenance

Replacement cartridges						
		3 x OVR 15 275 s C (2CTB813854R1100)	3 x OVR 15 440 C (2CTB813854R0600)	3 x OVR 40 275 C (2CTB813854R1000)	3 x OVR 40 275 s C (*) (2CTB813854R0900)	3 x OVR 40 440 C (2CTB813854R0400)
						3 x OVR 40 440 s C (*) (2CTB813854R0300)
						3 x OVR 70 275 C (2CTB813854R0800)
						3 x OVR 70 275 s C (*) (2CTB813854R0700)

ABB Surge Protective Device range

Pluggable multi-pole surge arresters - Type 2



OVR 4L 40 275 P

The pluggable multi-pole modular power Type 2 surge arresters provide protection for equipment against transient overvoltages that occur on the electrical network (mains), whatever the cause: atmospheric (lightning), industrial (operating overvoltages) or from interference.

The maximum available discharge currents (I_{max}) range from 15 to 70 kA (8/20 μ s waveform).

The range consists of 4-pole models.

Standards Info

The pluggable multi-pole power Type 2 surge arresters comply with IEC 61643-1 and EN 61643-11.

The relevant standard for the installation of this type of surge arrester is: IEC 61643-12.

Schematic diagrams

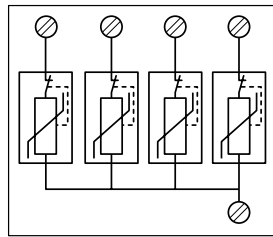

OVR 4L 15 / 40 / 70 P

Fixing

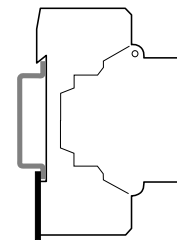

Simply clips onto DIN rail.

Dimensions

Dimensions (mm)	W (mm)	H (mm)	D (mm)
OVR 4L P (all models)	70	85	63

Connection

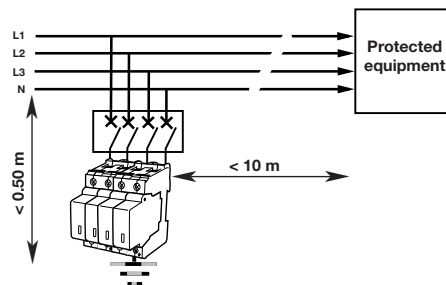

OVR 4L P (all models)

Types of network

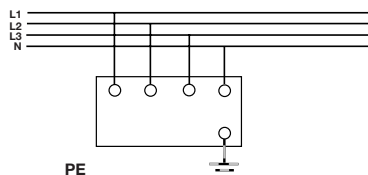

TNS networks

PRACTICAL INFO

Pluggable multi-pole surge arresters are installed in sub-distribution boards using DIN rail. They are used for common mode protection.

Maintenance is made easier with pluggable surge arresters as replacement cartridges can be simply plugged-in without the need to isolate the circuit.

ABB Surge Protective Device range

Pluggable multi-pole surge arresters - Characteristics

	15 kA (8/20)		40 kA (8/20)		70 kA (8/20)
	275 V	440 V	275 V	440 V	275 V
	OVR 4L 15 275 P (2CTB813853R6000) OVR 4L 15 275 s P (*) (2CTB813853R6700) OVR 4L 15 275 P TS (**) (2CTB813853R6800) OVR 4L 15 275 s P TS (*)(**) (2CTB813853R6900)	OVR 4L 15 440 P (2CTB813853R6100)	OVR 4L 40 275 P (2CTB813853R5600) OVR 4L 40 275 s P (*) (2CTB813853R5400) OVR 4L 40 275 P TS (**) (2CTB813853R5200) OVR 4L 40 275 s P TS (*)(**) (2CTB813853R5000)	OVR 4L 40 440 P (2CTB813853R5700) OVR 4L 40 440 s P (*) (2CTB813853R5500) OVR 4L 40 440 P TS (**) (2CTB813853R5300) OVR 4L 40 440 s P TS (*)(**) (2CTB813853R5100)	OVR 4L 70 275 P (2CTB813919R0100) OVR 4L 70 275 s P (*) (2CTB813919R0200) OVR 4L 70 275 P TS (**) (2CTB813919R0300) OVR 4L 70 275 s P TS (*)(**) (2CTB813919R0400)
More info					

Electrical characteristics

		TNS-TT	TNS-TT-IT	TNS-TT	TNS-TT-IT	TNS-TT
Types of network	p. 10					
Number of poles			4		4	4
Type of surge arrester			2		2	2
Type of current			A.C.		A.C.	A.C.
Nominal voltage: U _n	p. 7	230 V	400 V	230 V	400 V	230 V
Max. cont operating voltage: U _c	p. 8	275 V	440 V	275 V	440 V	275 V
Max. discharge current: I _{max} (8/20)	p. 7		15 kA		40 kA	70 kA
Nominal discharge current: I _n (8/20)	p. 7		5 kA		20 kA	30 kA
Voltage protection level: U _p at I _n	p. 7	1.0 kV	1.5 kV	1.4 kV	1.9 kV	1.5 kV
Residual voltage: U _{res} at 3 kA		0.9 kV	1.4 kV	0.9 kV	1.4 kV	0.85 kV
TOV withstand: U _T (5 s.)	p. 8	334 V	440 V	334 V	440 V	334 V
Continuous operating current: I _c			< 1 mA		< 1 mA	< 1 mA
Short-circuit withstand capability: I _{sc}			50 kA		50 kA	50 kA
Response time: t _A			≤ 25 ns		≤ 25 ns	≤ 25 ns
Associated breaking device:						
- gG - gL fuse	p. 45		16 A		16 A	20 A
- curve C circuit-breaker	p. 45		10 A		25 A	32 A

Mechanical and installation characteristics

L/N connection terminals:						
- solid wire				2.5 ... 25 mm ²		
- stranded wire				2.5 ... 16 mm ²		
L/N stripping length				12.5 mm		
L/N tightening torque				2 Nm		
PE connection terminal:						
- solid wire				2.5 ... 25 mm ²		
- stranded wire				2.5 ... 16 mm ²		
PE stripping length				12.5 mm		
PE tightening torque				2 Nm		
Integrated thermal disconnecter				Yes		
End of life indicator	p. 18			Yes		
Compatibility with OVR Sign	p. 18			Yes		
Safety reserve (s)	p. 18	Yes (*)	No	Yes (*)	Yes (*)	Yes (*)
Remote indicator (TS)	p. 18	Yes (**)	No	Yes (**)	Yes (**)	Yes (**)

Miscellaneous characteristics

Degree of protection				IP 20		
Temperature range				-40 °C to +80 °C		
Maximum altitude				2000 m		
Case material				PC grey RAL 7035		
Insulating material				UL94 V0 classification		
Reference standards				IEC 61643-1 / EN 61643-11		
Weight				400 g		

Maintenance

Replacement cartridges		4 x OVR 15 275 C (2CTB813854R1200) 4 x OVR 15 275 s C (*) (2CTB813854R1100)	4 x OVR 15 440 C (2CTB813854R0600)	4 x OVR 40 275 C (2CTB813854R1000) 4 x OVR 40 275 s C (*) (2CTB813854R0900)	4 x OVR 40 440 C (2CTB813854R0400) 4 x OVR 40 440 s C (*) (2CTB813854R0300)	4 x OVR 70 275 C (2CTB813854R0800) 4 x OVR 70 275 s C (*) (2CTB813854R0700)
------------------------	--	--	---------------------------------------	--	--	--

ABB Surge Protective Device range

Pluggable 75 V & 150 V surge arresters - Type 2



OVR 15 150 P



OVR 3N 70 150 s P TS

The pluggable 75 V & 150 V Type 2 surge arresters provide protection for equipment against transient overvoltages that occur on the electrical network (mains).

The maximum available discharge currents (I_{max}) range from 15 to 70 kA (8/20 μ s waveform).

Standards Info

The pluggable 75 V & 150 V Type 2 surge arresters comply with IEC 61643-1 and EN 61643-11.

The relevant standard for the installation of this type of surge arrester is: IEC 61643-12.

Schematic diagrams

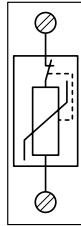

OVR 15 75 P
OVR 40 150 P
OVR 70 150 s P

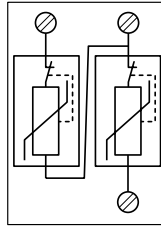

OVR 2 15 75 P
OVR 2 15 75 s P TS

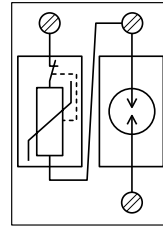

OVR 1N ... 150 P

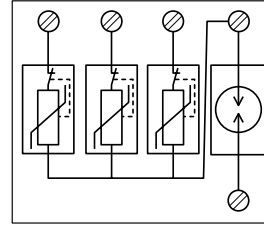

OVR 3N ... 150 P

Fixing

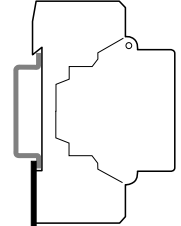

Simply clips onto DIN rail.

Dimensions

Dimensions	W (mm)	H (mm)	D (mm)
OVR 15 75 P / OVR 15 150 P / OVR 40 150 P / OVR 70 150 s P	17.5	85	63
OVR 2 15 75 (s) P (TS) / OVR 1N ... 150 P	35	85	63
OVR 3N ... 150 P	70	85	63

Connection

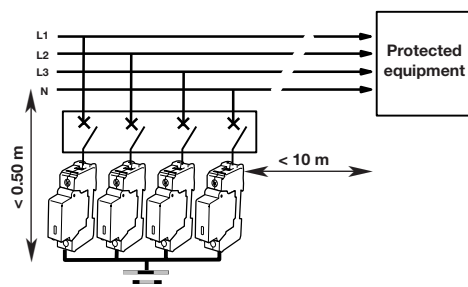

OVR 15 / 40 / 70 P

Types of network

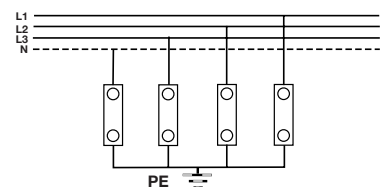

TT - TNS - IT networks (Single-pole all models)

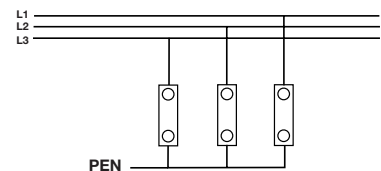

TNC networks (Single-pole all models)

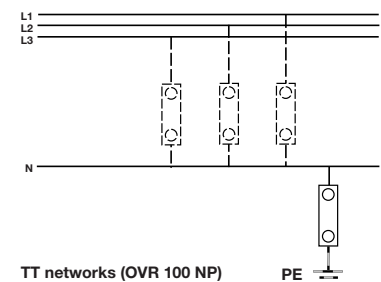

TT networks (OVR 100 NP)

PRACTICAL INFO

Pluggable 75 V & 150 V surge arresters are installed in sub-distribution boards using DIN rail. They are used for common mode protection. Maintenance is made easier with pluggable surge arresters as replacement cartridges can be simply plugged-in without the need to isolate the circuit.

ABB Surge Protective Device range

Pluggable 75 & 150 V surge arresters - Characteristics

		75 V			150 V								
	More info	OVR 15-75 P (2CTB813851R2800)	OVR 2-15-75 P (2CTB813852R1700)	OVR 2 15 75 s P TS (2CTB813852R1300)	OVR 15-150 P (2CTB813951R1700)	OVR 40-150 P (2CTB813951R1600)	OVR 70-150s P (2CTB813951R1200)	OVR 1N-15-150s P TS (2CTB813952R1600)	OVR 1N-40-150s P TS (2CTB813952R1500)	OVR 1N-70-150s P TS (2CTB813952R1400)	OVR 3N-15-150 P (2CTB813953R3100)	OVR 3N-40-150s P TS (2CTB813953R1500)	OVR 3N-70-150s P TS (2CTB813953R1400)
Electrical characteristic													
Types of network	p.10	TNC-TNS-TT	TNS-TT	TNC-TNS-TT	TNC-TNS-TT	TNC-TNS-TT	TNC-TNS-TT	TNS-TT	TNS-TT	TNS-TT	TNS-TT	TNS-TT	TNS-TT
Number of poles		1	2	2	1	1	1	2	2	2	4	4	4
Type of surge arrester		2	2	2	2	2	2	2	2	2	2	2	2
Type of current		A.C./D.C.	A.C./D.C.	A.C./D.C.	A.C.	A.C.	A.C.	A.C.	A.C.	A.C.	A.C.	A.C.	A.C.
Nominal voltage: U_n	p. 7	57 V	57 V	57 V	120 V	120 V	120 V	120 V	120 V	120 V	120 V	120 V	120 V
Max. cont operating voltage: U_c	p. 8	75 V	75 V	75 V	150 V	150 V	150 V	150 V	150 V	150 V	150 V	150 V	150 V
Max. discharge current: I_{max} (6/20)	p. 7	15 kA	15 kA	15 kA	15 kA	40 kA	70 kA	15 kA	40 kA	70 kA	15 kA	40 kA	70 kA
Nominal discharge current: I_n (6/20)	p. 7	5 kA	5 kA	5 kA	5 kA	20 kA	30 kA	15 kA	20 kA	30 kA	5 kA	20 kA	30 kA
Voltage protection level: U_p at I_n	p. 7	0.3 kV	0.3/0.6 kV	0.3/0.6 kV	0.6 kV	0.8 kV	0.8 kV	0.6 kV/1.4 kV	0.8 /1.4 kV	0.8 /1.4 kV	0.6 /1.4 kV	0.8 /1.4 kV	0.8 /1.4 kV
TOV withstand: U_T (5 s)	p. 8	N/A.	N/A.	N/A.	N/A.	N/A.	N/A.	N/A.	N/A.	N/A.	N/A.	N/A.	N/A.
Continuous operating current: I_c		< 1 mA	< 1 mA	< 1 mA	< 1 mA	< 1 mA	< 1 mA	< 1 mA	< 1 mA	< 1 mA	< 1 mA	< 1 mA	< 1 mA
Short-circuit withstand capability: I_{sc}		10 kA	10 kA	10 kA	50 kA	50 kA	50 kA	50 kA	50 kA	50 kA	50 kA	50 kA	50 kA
Response time: t_A		<25 ns	<25 ns	<25 ns	<25 ns	<25 ns	<25 ns	<25 ns	<25 ns	<25 ns	<25 ns	<25 ns	<25 ns
Associated breaking device:													
- gG - gL fuse	p. 45	16 A	16 A	16 A	16 A	16 A	20 A	16 A	16 A	20 A	16 A	16 A	20 A
- curve C circuit-breaker	p. 45	10 A	10 A	10 A	10 A	25 A	32 A	10 A	25 A	32 A	10 A	25 A	32 A
Mechanical and installation characteristics													
L/N connection terminals:													
- solid wire								2.5 ... 25 mm ²					
- stranded wire								2.5 ... 16 mm ²					
L/N stripping length								12.5 mm					
L/N tightening torque								2 Nm					
PE connection terminal:													
- solid wire								2.5 ... 25 mm ²					
- stranded wire								2.5 ... 16 mm ²					
PE stripping length								12.5 mm					
PE tightening torque								2 Nm					
Integrated thermal disconnecter								Yes					
End of life indicator	p. 18							Yes					
Compatibility with OVR Sign	p. 18							Yes					
Safety reserve (s)	p. 18	No	No	Yes	No	No	Yes	Yes	Yes	Yes	No	Yes	Yes
Remote indicator (TS)	p. 18	No	No	Yes	No	No	No	Yes	Yes	Yes	No	Yes	Yes
Miscellaneous characteristics													
Degree of protection								IP 20					
Temperature range								-40 °C to +80 °C					
Maximum altitude								2000 m					
Case material								PC grey RAL 7035					
Insulating material								UL94 V0 classification					
Reference standards								IEC 61643-1 / EN 61643-11					
Weight		120 g	120 g	200 g	120 g	120 g	120 g	230 g	230 g	230 g	460 g	460 g	460 g
Maintenance													
Replacement cartridges													
		OVR 15 75 C (2CTB813854R1400)	2 X OVR 15 75 C (2CTB813854R1400)	2 X OVR 15 75 s C (2CTB813854R1300)	OVR 15 150 C (2CTB813954R0700)	OVR 40 150 C (2CTB813954R0500)	OVR 70 150 s C (2CTB813954R0200)	OVR 15 150 s C (2CTB813954R0600) + OVR 70 NC (2CTB813854R0000)	OVR 40 150 s C (2CTB813954R0400) + OVR 70 NC (2CTB813854R0000)	OVR 70 150 s C (2CTB813954R0200) + OVR 70 NC (2CTB813854R0000)	OVR 15 150 C (2CTB813954R0700) + OVR 70 NC (2CTB813854R0000)	OVR 40 150 s C (2CTB813954R0400) + OVR 70 NC (2CTB813854R0000)	OVR 70 150 s C (2CTB813954R0200) + OVR 70 NC (2CTB813854R0000)

ABB Surge Protective Device range

Photovoltaic pluggable surge arresters



OVR PV 40 600 P



OVR PV 70 600 s P TS

The photovoltaic pluggable surge arresters provide protection for equipment on photovoltaic system (connected & standalone), against transient overvoltages that occur on the electrical network (mains).

The maximum available discharge currents (I_{max}) range from 30 to 70 kA (8/20 μ s waveform).

Standards Info

The pluggable photovoltaic surge arresters comply with IEC 61643-1 and EN 61643-11.

The relevant standard for the installation of this type of surge arrester is: IEC 61643-12.

Schematic diagrams

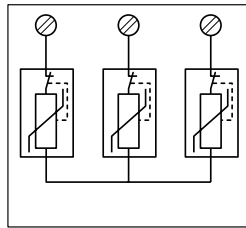

OVR PV 1000 V

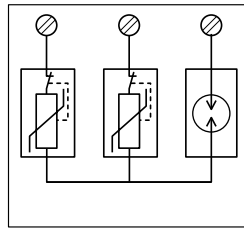

OVR PV 600 V

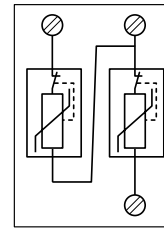

OVR PV 75 V

Fixing

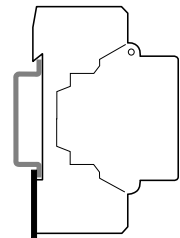

Simply clips onto DIN rail.

Dimensions

Dimensions	W (mm)	H (mm)	D (mm)
OVR PV ... 600 (s) P (TS)	42.5	85	58
OVR PV ... 1000 (s) P (TS)	42.5	85	58
OVR PV ... 75 (s) P (TS)	35	85	63

Connection

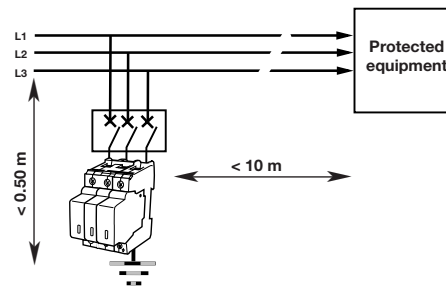

OVR PV ... 600 / 1000 V

PRACTICAL INFO

Pluggable photovoltaic surge arresters are installed in sub-distribution boards using DIN rail. They are used for common mode protection.

Maintenance is made easier with pluggable surge arresters as replacement cartridges can be simply plugged-in without the need to isolate the circuit.

ABB Surge Protective Device range

Photovoltaic surge arresters - Characteristics

	More info	Connected PV system			1000 V			Standalone PV system	
		600 V			1000 V			75 V	
		OVR PV 40 600 P (2CTB803953R5000)	OVR PV 40 600 P TS (2CTB803953R5100)	OVR PV 70 600 s P TS (2CTB803953R5200)	OVR PV 40 1000 P (2CTB803953R6100)	OVR PV 40 1000 P TS (2CTB803953R6200)	OVR PV 70 1000 s P TS (2CTB803953R6300)	OVR PV 30 75 P TS (2CTB803953R3100)	OVR PV 65 75 s P TS (2CTB803953R3200)
Electrical characteristics									
Types of network	p.10	Photovoltaic installations							
Number of poles		3							
Type of surge arrester		2							
Type of current		D.C.							
Nominal voltage: U_n	p. 7	600 V	600 V	600 V	1000 V	1000 V	1000 V	75 V	75 V
Max. cont operating voltage: U_c	p. 8	700 V	700 V	700 V	1120 V	1120 V	1120 V	100 V	100 V
Max. discharge current: I_{max} (8/20)	p. 7	40 kA	40 kA	70 kA	40 kA	40 kA	70 kA	30 kA	65 kA
Nominal discharge current: I_n (L-L / L-PE)	p. 7	20 kA	20 kA	30 kA	20 kA	20 kA	30 kA	10 kA	20 kA
Voltage protection level: U_p (L-L / L-PE)	p. 7	2.8 / 1.4 kV			3.8 kV			0.3 / 0.6 kV	
TOV withstand: U_T (5 s)	p. 8	N. / A.							
Continuous operating current: I_c		< 1 mA							
Short-circuit withstand capability: I_{sc}		N. / A.							
Response time: t_A		25 ns.							
Associated breaking device:									
- gG - gL fuse	p. 45	N. / A.							
- curve C circuit-breaker	p. 45	N. / A.							
Mechanical and installation characteristics									
L connection terminals:									
- solid wire		2.5 ... 25 mm ²							
- stranded wire		2.5 ... 16 mm ²							
L stripping length		12.5 mm							
L tightening torque		2.8 Nm							
PE connection terminal:									
- solid wire		2.5 ... 25 mm ²							
- stranded wire		2.5 ... 16 mm ²							
PE stripping length		12.5 mm							
PE tightening torque		2.8 Nm							
Integrated thermal disconnecter		Yes							
End of life indicator	p. 18	Yes							
Compatibility with OVR Sign	p. 18	No							
Safety reserve (s)	p. 18	No	No	Yes	No	No	Yes	No	Yes
Remote indicator (TS)	p. 18	No	Yes	Yes	No	Yes	Yes	Yes	Yes
Miscellaneous characteristics									
Degree of protection		IP 20							
Temperature range		-40 °C to +80 °C							
Maximum altitude		2000 m							
Case material		PC grey RAL 7035							
Insulating material		UL94 V2 classification							
Reference standards		IEC 61643-1 / EN 61643-11							
Weight		270 g						120 g	
Maintenance									
Replacement cartridges	p. 41	2 x OVR T2 40 275 C (2CTB803854R1000) + OVR T2 70 NC (2CTB803854R0000)	2 x OVR T2 40 275 C (2CTB803854R1000) + OVR T2 70 NC (2CTB803854R0000)	2 x OVR T2 70 275 s C (2CTB803854R0700) + OVR T2 70 NC (2CTB803854R0000)	3 x OVR T2 40 440 C (2CTB803854R0400)	3 x OVR T2 40 440 C (2CTB803854R0400)	3 x OVR T2 70 440 s C (2CTB803854R0100)	2x OVR T2 30 75 C (2CTB803854R1500)	2x OVR T2 65 75 s C (2CTB803854R1300)

ABB Surge Protective Device range

Low current modular surge arresters



OVR TC 06 V



OVR TC 200 FR

Transmission line surge arresters (OVR TC) provide protection against transient overvoltages for equipment connected to telephone lines (digital or analog), computer links or current loops, for applications such as RS-485, 4-20 mA.

Standards Info

Modular low current surge arresters comply with IEC 61643-21.

Schematic diagrams

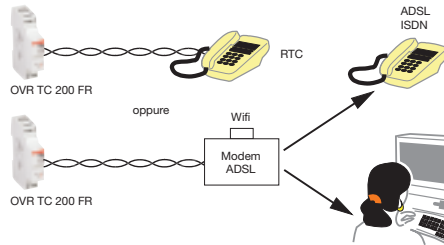

Protection of an analog line

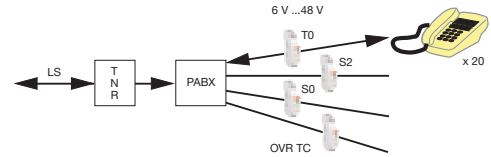

Protection of a digital line

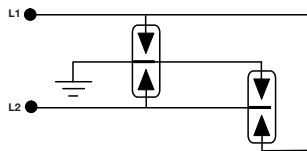

OVR TC 200 V in parallel

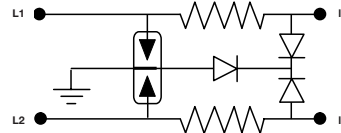

OVR TC / xx V / 200 FR in series

Dimensions

Dimensions	W (mm)	H (mm)	D (mm)
OVR TC (all models)	17.5	85	63

Connection

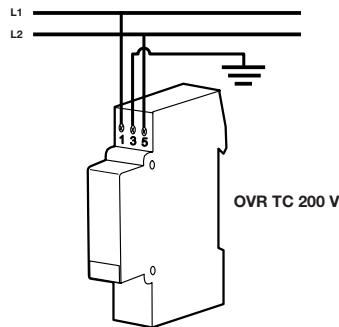

OVR TC 200 V in parallel

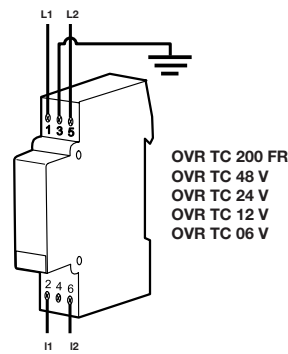

OVR TC / xx V / 200 FR in series

Fixing

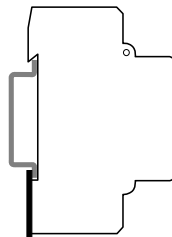

Simply clips onto DIN rail.

PRACTICAL INFO

Telecom and dataline protection surge arresters are installed in electrical switchboards or enclosures using DIN rail.

ABB Surge Protective Device range

Low current surge arresters - Characteristics

		6 V	12 V	24 V	48 V	200 V	200 V
	More info	OVR TC 06 V (2CTB813814R0100)	OVR TC 12 V (2CTB813814R0200)	OVR TC 24 V (2CTB813814R0300)	OVR TC 48 V (2CTB813814R0400)	OVR TC 200 V (2CTB813814R0500)	OVR TC 200 FR (2CTB813814R0000)
Electrical characteristics							
Types of network		MIC/T2 - RS 422/RS 485	RS 232	LS - 4/20 mA	RNIS - To	Commutated network	Analog - STN
Number of pairs		1	1	1	1	1	1
Type of protection		Series	Series	Series	Series	Parallel	Series
Type of current		Low currents	Low currents	Low currents	Low currents	Low currents	Low currents
Nominal voltage: U_n	p. 7	6 V	12 V	24 V	48 V	200 V	200 V
Max. cont operating voltage: U_c	p. 8	7 V	14 V	27 V	53 V	220 V	220 V
Max. discharge current: I_{max} (8/20)	p. 7	10 kA	10 kA	10 kA	10 kA	10 kA	10 kA
Nominal discharge current: I_n (8/20)	p. 7	5 kA	5 kA	5 kA	5 kA	5 kA	5 kA
Voltage protection level: U_p at I_n	p. 7	15 V	20 V	35 V	70 V	700 V	300 V
Bandwidth		10 MHz	2 MHz	4 MHz	6 MHz	100 MHz	3 MHz
Continuous operating current: I_c		140 mA	140 mA	140 mA	140 mA	-	140 mA
50 Hz withstand (15 mn)		10 A	10 A	10 A	10 A	-	10 A
Mechanical and installation characteristics							
L/N connection terminals:							
- solid wire					0.5 ... 2.5 mm ²		
- stranded wire					0.5 ... 2.5 mm ²		
PE connection terminal:							
- solid wire					0.5 ... 2.5 mm ²		
- stranded wire					0.5 ... 2.5 mm ²		
Integrated thermal disconnecter	p. 18		Yes			No	Yes
End of life indicator	p. 18		Yes			No	Yes
Compatibility with OVR Sign	p. 18		Yes			No	Yes
Miscellaneous characteristics							
Degree of protection					IP 20		
Temperature range					-40 °C to +80 °C		
Maximum altitude					2000 m		
Case material					PC grey RAL 7035		
Insulating material					UL94 V0 classification		
Reference standard					IEC 61643-21		
Weight					150 g		

Installation rules for surge arresters

Positioning

The incoming surge arrester is fitted immediately downstream the installation's main isolating device.

The surge arrester must:

- be consistent with the allowable voltages of the equipment to be protected.
- be close by the equipment to be protected.
- be coordinated with the other surge arresters.

What measures are to be taken to limit overvoltages ?

Avoid rings over large surfaces and use the same routing for the power and low current cables whilst respecting spacing and crossing rules for the two networks.

Be aware of the equipment and installations (lifts, lightning rods) that generate overvoltages. Identify their position with respect to sensitive equipment and either ensure there is sufficient distance between them or that overvoltage protection is installed.

Favour the use of screening for equipment and cables, and carry out equipotential bonding using braiding of a shorter length as possible between all metallic parts entering, leaving or within the building.

Be aware of the different earthing systems in order to adapt the overvoltage protection and avoid the TN-C system if there is sensitive equipment in the installation.

Correctly select the thermal and short-circuit protection devices. Favour type S (delayed or selective) Residual Current Device (D 90 or F 390) for protection against indirect contact in order to avoid nuisance tripping.





Installation rules

Choice of associated breaking device (fuse / circuit-breaker)

Choice of disconnecter

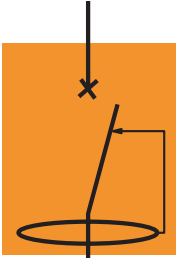
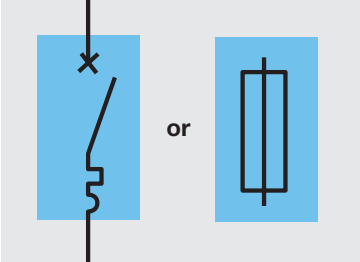
Surge arresters must be associated with upstream short-circuit protection and residual current protection against indirect contact (usually already present in the installation).

	Function	Application
	Protection against indirect contact	<ul style="list-style-type: none"> Residual current circuit-breaker compulsory for TT systems Residual current circuit-breaker possible for TN-S, IT and TN-C-S systems Residual current circuit-breaker forbidden for TN-C systems <p>If a residual current circuit-breaker is used, it is preferable to use a type S.</p> <p>Otherwise there is a risk of nuisance tripping.</p> <p>This does not affect the effectiveness of the surge arrester, but may cause the circuit to be opened.</p>
	Protection against fault currents	<p>The breaking device associated with the surge arrester can be either a circuit breaker or a fuse.</p> <p>Its rating should take into consideration the surge arrester's characteristics and the short-circuit current of the installation.</p>
	Thermal protection	<p>Thermal protection is integrated into the surge arrester.</p>

Installation rules

Wiring / connection

Possible

Priority is given to protection

$I1 < I$ surge arrester

Priority is given to continuity of service

$I1 > I$ surge arrester and $I2 < I$ surge arrester

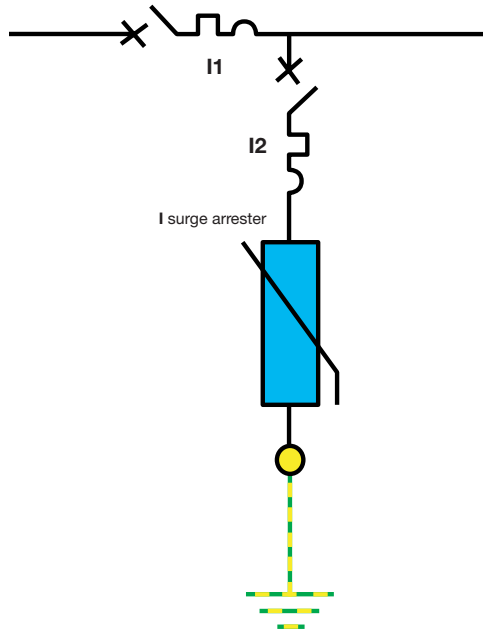
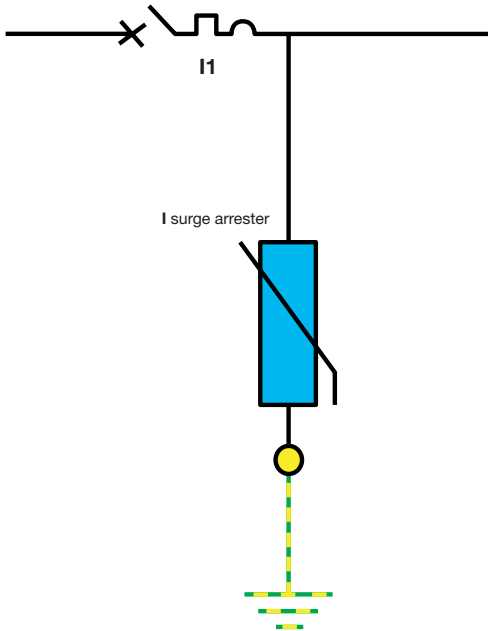

Forbiden

$I1 > I$ surge arrester

No protection

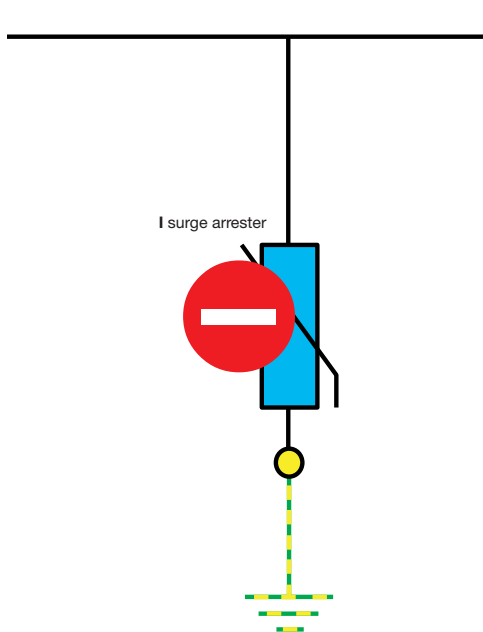
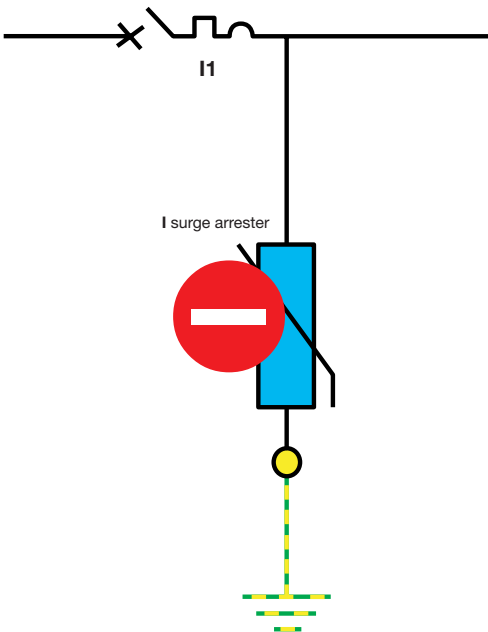

Note:

Priority is given to protection:

At the end of the surge arrester's service life, the rest of the installation can no longer be fed.

The surge arrester that has failed must be replaced.

Priority is given to continuity of service:

At the end of the surge arrester's service life, it can be isolated from the rest of the installation.

The network can be re-established without the need to rewire the switchboard.

In this configuration, the equipment is no longer protected.

Replace the surge arrester as quickly as possible.

- **I1** and **I2**: current ratings of the circuit-breaker(s) or fuse(s).

- **I** surge arrester: recommended current for surge arrester protection (see table on the following page).

Installation rules

Choice of disconnecter (fuse / circuit-breaker)

Maximum circuit-breaker or fuse protection rating depending on I_{max} and I_{imp} of the surge arrester.

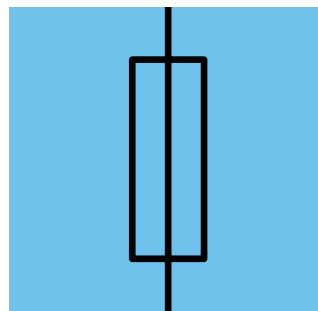
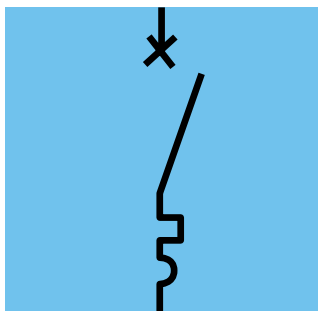

Type 1 surge arresters	Circuit-breaker (curve C)	Fuse (gG)
25 kA (10/350): OVR T1	-	≤ 125 A
Type 1+2 surge arresters	Circuit-breaker (curve C)	Fuse (gG)
15 or 25 kA (10/350): OVR T1+2	-	≤ 125 A
15 kA (10/350): OVR HL		
• $I_p = 300$ A to 1 kA	40 A (1)	25 A
• $I_p = 1$ kA to 7 kA	40 A to 50 A (2)	50 A
• $I_p = 7$ kA and above	40 A to 50 A (3)	63 A
7 kA (10/350): OVR T1+2		
• $I_p = 300$ A to 1 kA	32 A (1)	20 A
• $I_p = 1$ kA to 7 kA	32 A to 40 A (2)	40 A
• $I_p = 7$ kA and above	32 A to 63 A (3)	63 A
Type 2 surge arresters	Circuit-breaker (curve C)	Fuse (gG)
100 kA (8/20)		
• $I_p = 300$ A to 1 kA	40 A (1)	25 A
• $I_p = 1$ kA to 7 kA	40 A to 50 A (2)	50 A
• $I_p = 7$ kA and above	40 A to 50 A (3)	63 A
70 kA (8/20)		
• $I_p = 300$ A to 1 kA	32 A (1)	20 A
• $I_p = 1$ kA to 7 kA	32 A to 40 A (2)	40 A
• $I_p = 7$ kA and above	32 A to 63 A (3)	63 A
40 kA (8/20)		
• $I_p = 300$ A to 1 kA	25 A (1)	16 A
• $I_p = 1$ kA to 7 kA	25 A (2)	25 A
• $I_p = 7$ kA and above	25 A to 50 A (3)	50 A
15 kA (8/20)		
• $I_p = 300$ A to 1 kA	10 A to 25 A (1)	16 A
• $I_p = 1$ kA to 7 kA	10 A to 32 A (2)	16 A
• $I_p = 7$ kA and above	10 A to 40 A (3)	25 A to 40 A

(1) Series S 200 L or S 941 N.

(2) Series S 200 L and S 200 / S 200 M.

(3) Series S 200 M / S 200 P / S 500 / S 800.

Installation rules

Wiring diagrams according to the earthing system

Three-phase TNC system (for 230 V installations)

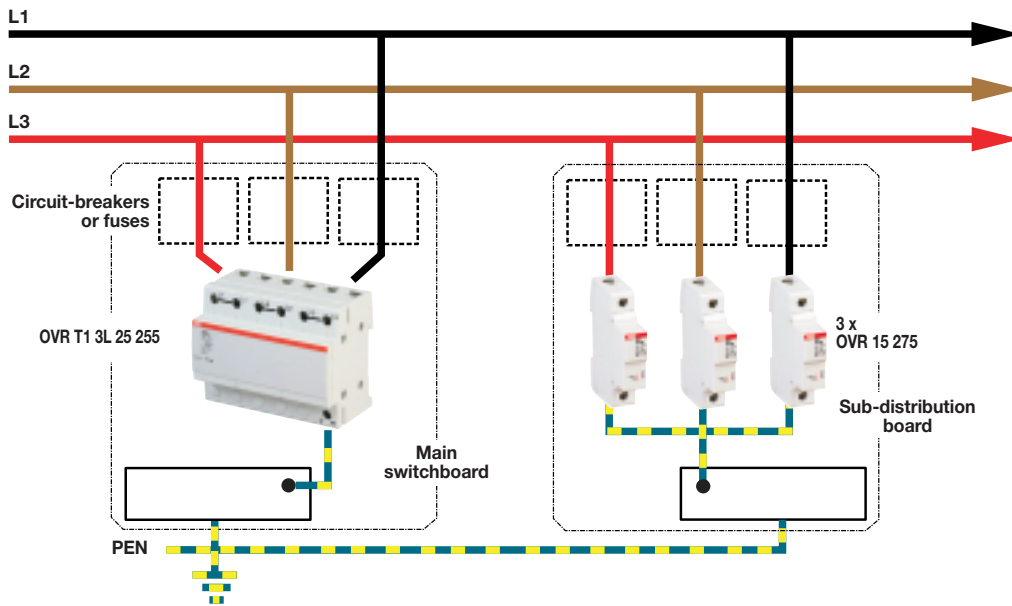

Three-phase + Neutral IT system

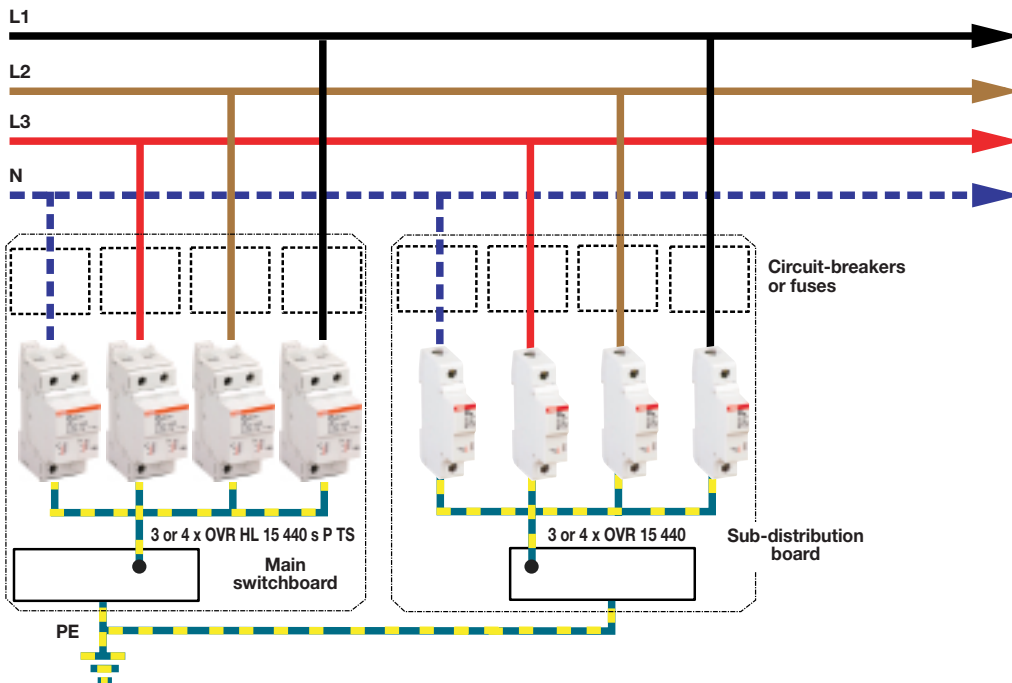

Note:

If continuity of service is essential, the "isolated neutral" (IT) configuration is the most reliable way of limiting breaks in the supply.

Installation rules

Wiring diagrams according to the earthing system

Three-phase + Neutral TNS system

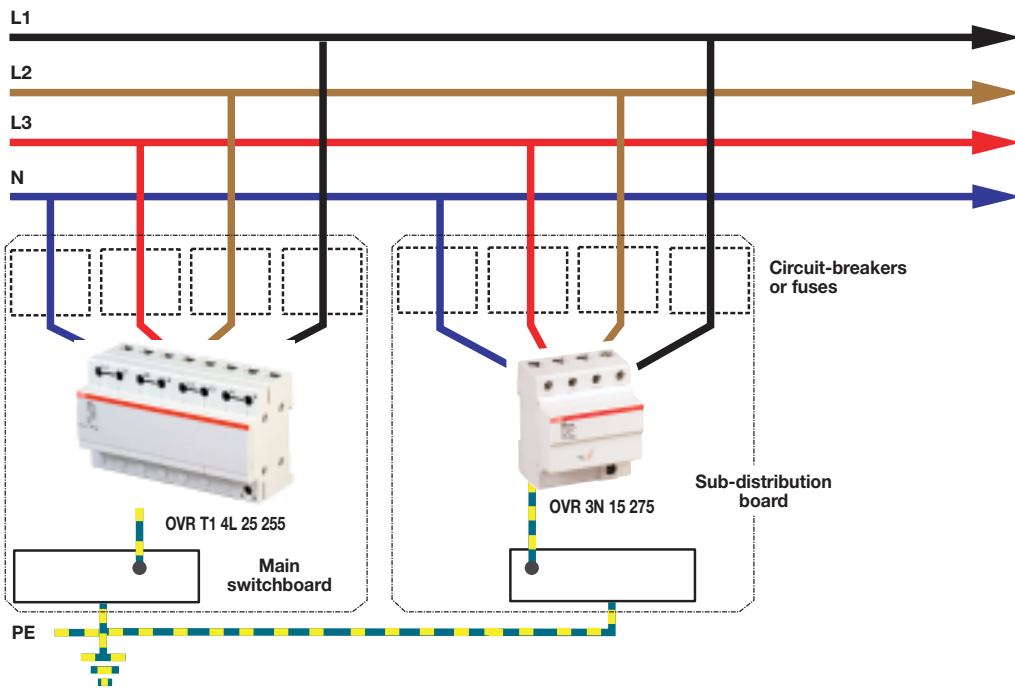

Single-phase TT system

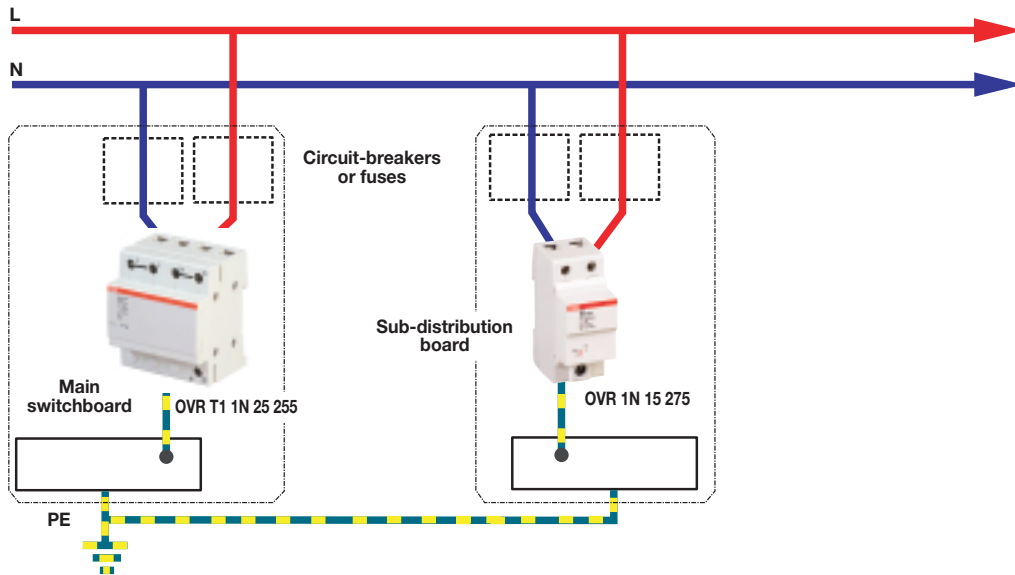

Installation rules

Cabling and installations of surge arresters in an electrical panel

50 cm rule

Remember that a 10 kA lightning current passing through a 1 m length of cable generates 1000 Volts. Equipment protected by a surge arrester is subjected to a voltage equal to the sum of the U_p voltage of the surge arrester, U_d of its disconnector and the sum of the inductive voltages of connecting cables ($U_1+U_2+U_3$).

It is therefore essential that the total length ($L = L_1+L_2+L_3$) of the connecting cables is as short as possible (0.50 m).

If this length ($L = L_1 + L_2+L_3$) exceeds 0.50m, it is necessary to carry out one of the following:

- Reduce this length by moving the connection terminals.
- Choose a surge arrester with a lower U_p value.
- Install a second, coordinated surge arrester near the device to be protected so as to adapt the combined U_p value to the impulse withstand of the equipment to be protected.

Wiring ring surfaces

The wires must be arranged in such a way that they are as close to each other as possible (see adjacent diagram) to avoid overvoltages induced by a ring surface between phases, the neutral and the PE conductor.

Routing of clean cables and polluted cables

During installation, lay clean cables (protected) and polluted cables as shown in the adjacent diagrams.

To avoid magnetic coupling between the different cable types (clean and polluted), it is strongly advised that they are kept apart (> 30 cm) and if a crossing cannot be avoided, it should be at right angles (90°).

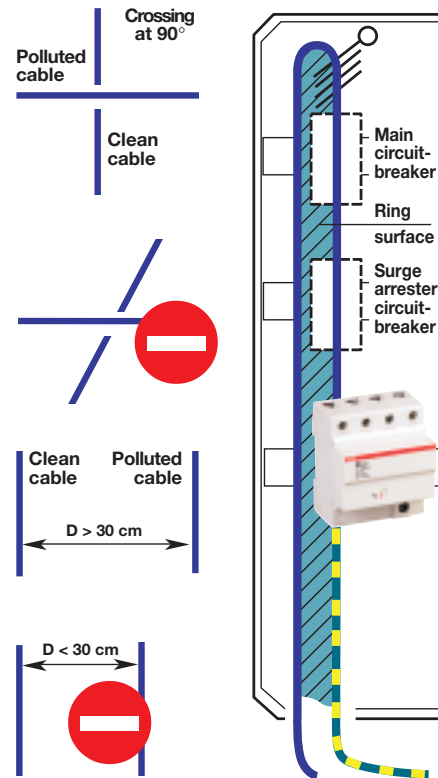
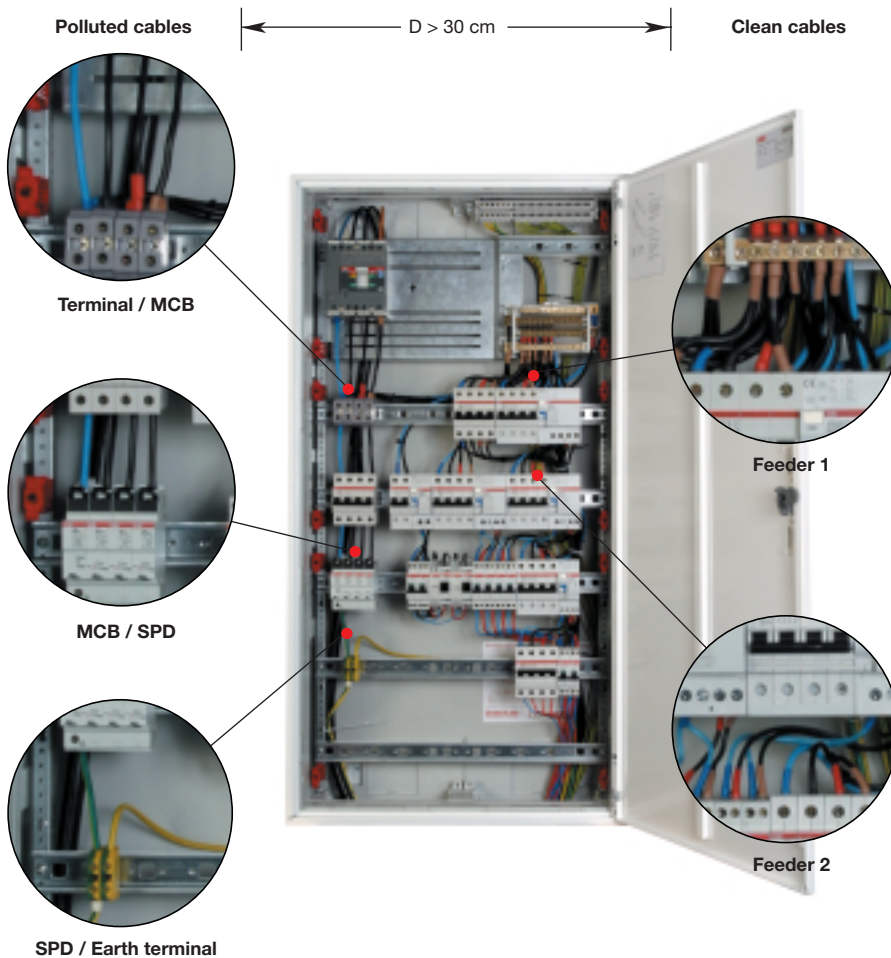
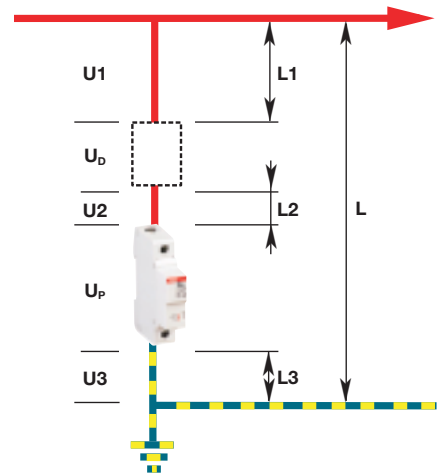

Note:

The cross-section of the connecting cables is calculated according to the local short-circuit current level (where the surge arrester is installed). It must be equal to the cross-section of the installation's upstream cables.

The minimum cross-section for the earth conductor is 4 mm² if there is not a lightning conductor and 10 mm² if there is a lightning conductor.

Equipotential grounding:

It is critical to check the earth equipotentiality of the various items of equipment.

Index

by reference

Reference	Code	Page	Reference	Code	Page
OVR 15 150 C	2CTB813954R0700	39	OVR HL 15 255 s C	2CTB815250R0400	23
OVR 15 150 s C	2CTB813954R0600	39	OVR HL 15 255 s P TS	2CTB815201R0900	23
OVR 15 275	2CTB813811R0800	25	OVR HL 15 440 s C	2CTB815250R0300	23
OVR 15 275 C	2CTB813854R1200	29, 31, 33, 37	OVR HL 15 440 s P TS	2CTB815201R0800	23
OVR 15 275 P	2CTB813851R2400	29	OVR HL 2L 15 440 s P TS	2CTB815303R0400	23
OVR 15 275 s C	2CTB813854R1100	35, 37	OVR HL 3L 15 440 s P TS	2CTB815401R0400	23
OVR 15 440	2CTB813811R0400	25	OVR HL 4L 15 440 s P TS	2CTB815503R0400	23
OVR 15 440 C	2CTB813854R0600	29, 33, 35, 37	OVR PV 30 75 P TS	2CTB803953R3100	41
OVR 15 440 P	2CTB813851R1200	29	OVR PV 40 1000 P	2CTB803953R6100	41
OVR 15 440 P TS	2CTB813851R0600	29	OVR PV 40 1000 P TS	2CTB803953R6200	41
OVR 15 75 C	2CTB813854R1400	39	OVR PV 40 600 P	2CTB803953R5000	41
OVR 15 75 s C	2CTB813854R1300	39	OVR PV 40 600 P TS	2CTB803953R5100	41
OVR 15-150 P	2CTB813951R1700	39	OVR PV 65 75 s P TS	2CTB803953R3200	41
OVR 15-75 P	2CTB813851R2800	39	OVR PV 70 1000 s P TS	2CTB803953R6300	41
			OVR PV 70 600 P TS	2CTB803953R5200	41
OVR 1N 10 275	2CTB813912R1000	27	OVR T1 25 255	2CTB815101R0100	21
OVR 1N 15 275	2CTB813912R0400	27	OVR T1 25 255-7	2CTB815101R8700	21
OVR 1N 15 275 P	2CTB813952R1200	31	OVR T1 25 440-50	2CTB815101R9300	21
OVR 1N 15 275 P TS	2CTB813952R0600	31	OVR T1 3L 25 255	2CTB815101R1300	21
OVR 1N 40 275	2CTB813912R0300	27	OVR T1 3L 25 255 TS	2CTB815101R0600	21
OVR 1N 40 275 P	2CTB813952R1100	31	OVR T1 4L 25 255	2CTB815101R1400	21
OVR 1N 40 275 P TS	2CTB813952R0500	31	OVR T1 4L 25 255 TS	2CTB815101R0800	21
OVR 1N 40 275 s P	2CTB813952R0800	31	OVR T1 1N 25 255	2CTB815101R1500	21
OVR 1N 40 275 s P TS	2CTB813952R0200	31	OVR T1 1N 25 255 TS	2CTB815101R1000	21
OVR 1N 70 275 P	2CTB813952R1000	31	OVR T1 3N 25 255	2CTB815101R1600	21
OVR 1N 70 275 P TS	2CTB813952R0400	31	OVR T1 3N 25 255 TS	2CTB815101R0700	21
OVR 1N 70 275 s P	2CTB813952R0700	31	OVR T1 3N 25 255-7	2CTB815101R8800	21
OVR 1N 70 275 s P TS	2CTB813952R0100	31	OVR T1 50 N	2CTB815101R0400	21
OVR 1N-15-150s P TS	2CTB813952R1600	39	OVR T1 100 N	2CTB815101R0500	21
OVR 1N-40-150s P TS	2CTB813952R1500	39	OVR T1+2 15 255-7	2CTB815101R8900	23
OVR 1N-70-150s P TS	2CTB813952R1400	39	OVR T1+2 25 255 TS	2CTB815101R0300	23
			OVR T1+2 3L 7 275 s P	2CTB815101R4000	23
OVR 2 15 75 s P TS	2CTB813852R1300	39	OVR T1+2 3N 15 255-7	2CTB815101R9000	23
OVR 2-15-75 P	2CTB813852R1700	39	OVR T1+2 4L 7 275 s P	2CTB815101R4100	23
			OVR T1+2 7 275 s P	2CTB815101R3900	23
OVR 2L 65 440	2CTB813912R0200	27	OVR T1+2 7 275 s C	2CTB815501R3800	23
OVR 2L 65 440 s	2CTB813812R0700	27	OVR T2 30 75 C	2CTB803854R1500	41
OVR 3L 15 440 P	2CTB813853R3000	35	OVR T2 40 275 C	2CTB803854R1000	41
OVR 3L 15 440 P TS	2CTB813853R3200	35	OVR T2 40 440 C	2CTB803854R0400	41
OVR 3L 40 275 P	2CTB813853R2400	33	OVR T2 65 75 s C	2CTB803854R1300	41
OVR 3L 40 275 P TS	2CTB813853R2500	35	OVR T2 70 275 s C	2CTB803854R0700	41
OVR 3L 40 275 s P	2CTB813853R2200	35	OVR T2 70 440 s C	2CTB803854R0100	41
OVR 3L 40 275 s P TS	2CTB813853R2300	35	OVR T2 70 NC	2CTB803854R0000	41
OVR 3L 40 440 P	2CTB813853R2800	35	OVR TC 06 V	2CTB813814R0100	43
OVR 3L 40 440 P TS	2CTB813853R2900	35	OVR TC 12 V	2CTB813814R0200	43
OVR 3L 40 440 s P	2CTB813853R2600	35	OVR TC 200 FR	2CTB813814R0000	43
OVR 3L 40 440 s P TS	2CTB813853R2700	35	OVR TC 200 V	2CTB813814R0500	43
OVR 3L 70 275 P	2CTB813853R4200	35	OVR TC 24 V	2CTB813814R0300	43
OVR 3L 70 275 P TS	2CTB813853R4300	35	OVR TC 48 V	2CTB813814R0400	43
OVR 3L 70 275 s P	2CTB813853R4100	35			
OVR 3L 70 275 s P TS	2CTB813853R4400	35			
			OVR 40 150 C	2CTB813954R0500	39
OVR 3N 10 275	2CTB813913R1000	27	OVR 40 150 s C	2CTB813954R0400	39
OVR 3N 15 275	2CTB813913R0400	27	OVR 40 275	2CTB813811R0700	25
OVR 3N 15 275 P	2CTB813953R1200	33	OVR 40 275 C	2CTB813854R1000	29, 31, 33, 35, 37
OVR 3N 15 275 P TS	2CTB813953R0600	33	OVR 40 275 P	2CTB813851R2300	29
OVR 3N 15 440 P	2CTB813953R6100	33	OVR 40 275 P TS	2CTB813851R1700	29
OVR 3N 40 275	2CTB813913R0300	27	OVR 40 275 s	2CTB813811R1000	25
OVR 3N 40 275 P	2CTB813953R1100	33	OVR 40 275 s C	2CTB813854R0900	29, 31, 33, 35, 37
OVR 3N 40 275 P TS	2CTB813953R0500	33	OVR 40 275 s P	2CTB813851R2000	29
OVR 3N 40 275 s P	2CTB813953R0800	33	OVR 40 275 s P TS	2CTB813851R1400	29
OVR 3N 40 275 s P TS	2CTB813953R0200	33	OVR 40 440	2CTB813811R0300	25
OVR 3N 40 440 P	2CTB813953R4100	33	OVR 40 440 C	2CTB813854R0400	29, 35, 37
OVR 3N 40 440 P TS	2CTB813953R4200	33	OVR 40 440 P TS	2CTB813851R1000	29
OVR 3N 40 440 s P	2CTB813953R6200	33	OVR 40 440 s	2CTB813811R0900	25
OVR 3N 40 440 s P TS	2CTB813953R1300	33	OVR 40 440 s C	2CTB813854R0300	35, 37
OVR 3N 70 275 P	2CTB813953R1000	33	OVR 40 440 s P TS	2CTB813851R0200	29
OVR 3N 70 275 P TS	2CTB813953R0400	33	OVR 40-150 P	2CTB813951R1600	39
OVR 3N 70 275 s P	2CTB813953R0700	33			
OVR 3N 70 275 s P TS	2CTB813953R0100	33	OVR 65 275	2CTB813811R0600	25
OVR 3N 70 440 s P	2CTB813953R4300	33	OVR 65 275 s	2CTB813811R0500	25
OVR 3N 70 440 s P TS	2CTB813953R4400	33	OVR 65 440	2CTB813811R0200	25
OVR 3N-15-150 P	2CTB813953R3100	39	OVR 65 440 s	2CTB813811R0100	25
OVR 3N-40-150s P TS	2CTB813953R1500	39			
OVR 3N-70-150s P TS	2CTB813953R1400	39			
			OVR 70 440 s C	2CTB813854R0100	29
OVR 4L 15 275 P	2CTB813853R6000	37	OVR 70 150 s C	2CTB813954R0200	39
OVR 4L 15 275 P TS	2CTB813853R6800	37	OVR 70 275 C	2CTB813854R0800	29, 37, 33, 37
OVR 4L 15 275 s P	2CTB813853R6700	37	OVR 70 275 P	2CTB813851R2200	29
OVR 4L 15 275 s P TS	2CTB813853R6900	37	OVR 70 275 P TS	2CTB813851R1600	29
OVR 4L 15 440 P	2CTB813853R6100	37	OVR 70 275 s C	2CTB813854R0700	29, 31, 33, 35, 37
OVR 4L 40 275 P	2CTB813853R5600	37	OVR 70 275 s P	2CTB813851R1900	29
OVR 4L 40 275 P TS	2CTB813853R5200	37	OVR 70 275 s P TS	2CTB813851R1300	29
OVR 4L 40 275 s P	2CTB813853R5400	37	OVR 70 440 C	2CTB813854R0200	29
OVR 4L 40 275 s P TS	2CTB813853R5000	37	OVR 70 440 P	2CTB813851R1000	29
OVR 4L 40 440 P	2CTB813853R5700	37	OVR 70 440 P TS	2CTB813854R0400	29
OVR 4L 40 440 P TS	2CTB813853R5300	37	OVR 70 440 s C	2CTB813854R0100	29, 33
OVR 4L 40 440 s P	2CTB813853R5500	37	OVR 70 440 s P	2CTB813851R0700	29
OVR 4L 40 440 s P TS	2CTB813853R5100	37	OVR 70 440 s P TS	2CTB813851R1000	29
OVR 4L 65 440	2CTB813913R0200	27	OVR 70 N C	2CTB813854R0000	29, 31, 33, 39
OVR 4L 65 440 s	2CTB813913R0100	27	OVR 70 NP	2CTB813951R0100	29
OVR 4L 70 275 P	2CTB813919R0100	37	OVR 70-150s P	2CTB813951R1200	39
OVR 4L 70 275 P TS	2CTB813919R0300	37			
OVR 4L 70 275 s P	2CTB813919R0200	37	OVR 100 275 s	2CTB813811R1200	25
OVR 4L 70 275 s P TS	2CTB813919R0400	37	OVR 100 275 s P TS	2CTB813850R0200	29
			OVR 100 440 s	2CTB813811R1100	25
			OVR 100 440 s P TS	2CTB813850R0100	29
			OVR 100 NP	2CTB813850R0300	29

Index

by code

Code	Reference	Page
2CTB803854R0000	OVR T2 70 NC	41
2CTB803854R0100	OVR T2 70 440 s C	41
2CTB803854R0400	OVR T2 40 440 C	41
2CTB803854R0700	OVR T2 70 275 s C	41
2CTB803854R1000	OVR T2 40 275 C	41
2CTB803854R1300	OVR T2 65 75 s C	41
2CTB803854R1500	OVR T2 30 75 C	41
2CTB803953R3100	OVR PV 30 75 P TS	41
2CTB803953R3200	OVR PV 65 75 s P TS	41
2CTB803953R5000	OVR PV 40 600 P	41
2CTB803953R5100	OVR PV 40 600 P TS	41
2CTB803953R5200	OVR PV 70 600 P TS	41
2CTB803953R6100	OVR PV 40 1000 P	41
2CTB803953R6200	OVR PV 40 1000 P TS	41
2CTB803953R6300	OVR PV 70 1000 s P TS	41
2CTB813811R0100	OVR 65 440 s	25
2CTB813811R0200	OVR 65 440	25
2CTB813811R0300	OVR 40 440	25
2CTB813811R0400	OVR 15 440	25
2CTB813811R0500	OVR 65 275 s	25
2CTB813811R0600	OVR 65 275	25
2CTB813811R0700	OVR 40 275	25
2CTB813811R0800	OVR 15 275	25
2CTB813811R0900	OVR 40 440 s	25
2CTB813811R1000	OVR 40 275 s	25
2CTB813811R1100	OVR 100 440 s	25
2CTB813811R1200	OVR 100 275 s	25
2CTB813812R0700	OVR 2L 65 440 s	27
2CTB813814R0000	OVR TC 200 FR	43
2CTB813814R0100	OVR TC 06 V	43
2CTB813814R0200	OVR TC 12 V	43
2CTB813814R0300	OVR TC 24 V	43
2CTB813814R0400	OVR TC 48 V	43
2CTB813814R0500	OVR TC 200 V	43
2CTB813850R0100	OVR 100 440 s P TS	29
2CTB813850R0200	OVR 100 275 s P TS	29
2CTB813850R0300	OVR 100 NP	29
2CTB813851R0100	OVR 70 440 s P TS	29
2CTB813851R0200	OVR 40 440 s P TS	29
2CTB813851R0400	OVR 70 440 P TS	29
2CTB813851R0500	OVR 40 440 P TS	29
2CTB813851R0600	OVR 15 440 P TS	29
2CTB813851R0700	OVR 70 440 s P	29
2CTB813851R1000	OVR 70 440 P	29
2CTB813851R1200	OVR 15 440 P	29
2CTB813851R1300	OVR 70 275 s P TS	29
2CTB813851R1400	OVR 40 275 s P TS	29
2CTB813851R1600	OVR 70 275 P TS	29
2CTB813851R1700	OVR 40 275 P TS	29
2CTB813851R1900	OVR 70 275 s P	29
2CTB813851R2000	OVR 40 275 s P	29
2CTB813851R2200	OVR 70 275 P	29
2CTB813851R2300	OVR 40 275 P	29
2CTB813851R2400	OVR 15 275 P	29
2CTB813851R2800	OVR 15-75 P	39
2CTB813852R1300	OVR 2 15 75 s P TS	39
2CTB813852R1700	OVR 2-15-75 P	39
2CTB813853R2200	OVR 3L 40 275 s P	35
2CTB813853R2300	OVR 3L 40 275 s P TS	35
2CTB813853R2400	OVR 3L 40 275 P	35
2CTB813853R2500	OVR 3L 40 275 P TS	35
2CTB813853R2600	OVR 3L 40 440 s P	35
2CTB813853R2700	OVR 3L 40 440 s P TS	35
2CTB813853R2800	OVR 3L 40 440 P	35
2CTB813853R2900	OVR 3L 40 440 P TS	35
2CTB813853R3000	OVR 3L 15 440 P	35
2CTB813853R3200	OVR 3L 15 440 P TS	35
2CTB813853R4100	OVR 3L 70 275 s P	35
2CTB813853R4200	OVR 3L 70 275 P	35
2CTB813853R4300	OVR 3L 70 275 P TS	35
2CTB813853R4400	OVR 3L 70 275 s P TS	35
2CTB813853R5000	OVR 4L 40 275 s P TS	37
2CTB813853R5100	OVR 4L 40 440 s P TS	37
2CTB813853R5200	OVR 4L 40 275 P TS	37
2CTB813853R5300	OVR 4L 40 440 P TS	37
2CTB813853R5400	OVR 4L 40 275 s P	37
2CTB813853R5500	OVR 4L 40 440 s P	37
2CTB813853R5600	OVR 4L 40 275 P	37
2CTB813853R5700	OVR 4L 40 440 P	37
2CTB813853R6000	OVR 4L 15 275 P	37
2CTB813853R6100	OVR 4L 15 440 P	37
2CTB813853R6700	OVR 4L 15 275 s P	37
2CTB813853R6800	OVR 4L 15 275 P TS	37
2CTB813853R6900	OVR 4L 15 275 s P TS	37
2CTB813854R0000	OVR 70 N C	29, 31, 33, 39
2CTB813854R0100	OVR 70 440 s C	29
2CTB813854R0100	OVR 70 440 s C	29, 33
2CTB813854R0200	OVR 70 440 C	29
2CTB813854R0300	OVR 40 440 s C	35, 37
2CTB813854R0400	OVR 40 440 C	29, 35, 37
2CTB813854R0600	OVR 15 440 C	29, 33, 35, 37
2CTB813854R0700	OVR 70 275 s C	29, 31, 33, 35, 37

Code	Reference	Page
2CTB813854R0800	OVR 70 275 C	29, 37, 33, 37
2CTB813854R0900	OVR 40 275 s C	29, 31, 33, 35, 37
2CTB813854R1000	OVR 40 275 C	29, 31, 33, 35, 37
2CTB813854R1100	OVR 15 275 s C	35, 37
2CTB813854R1200	OVR 15 275 C	29, 31, 33, 37
2CTB813854R1300	OVR 15 75 s C	39
2CTB813854R1400	OVR 15 75 C	39
2CTB813912R0200	OVR 2L 65 440	27
2CTB813912R0300	OVR 1N 40 275	27
2CTB813912R0400	OVR 1N 15 275	27
2CTB813912R1000	OVR 1N 10 275	27
2CTB813913R0100	OVR 4L 65 440 s	27
2CTB813913R0200	OVR 4L 65 440	27
2CTB813913R0300	OVR 3N 40 275	27
2CTB813913R0400	OVR 3N 15 275	27
2CTB813913R1000	OVR 3N 10 275	27
2CTB813919R0100	OVR 4L 70 275 P	37
2CTB813919R0200	OVR 4L 70 275 s P	37
2CTB813919R0300	OVR 4L 70 275 P TS	37
2CTB813919R0400	OVR 4L 70 275 s P TS	37
2CTB813951R0100	OVR 70 NP	29
2CTB813951R1200	OVR 70-150s P	39
2CTB813951R1600	OVR 40-150 P	39
2CTB813951R1700	OVR 15-150 P	39
2CTB813952R0100	OVR 1N 70 275 s P TS	31
2CTB813952R0200	OVR 1N 40 275 s P TS	31
2CTB813952R0400	OVR 1N 70 275 P TS	31
2CTB813952R0500	OVR 1N 40 275 P TS	31
2CTB813952R0600	OVR 1N 15 275 P TS	31
2CTB813952R0700	OVR 1N 70 275 s P	31
2CTB813952R0800	OVR 1N 40 275 s P	31
2CTB813952R1000	OVR 1N 70 275 P	31
2CTB813952R1100	OVR 1N 40 275 P	31
2CTB813952R1200	OVR 1N 15 275 P	31
2CTB813952R1400	OVR 1N-70-150s P TS	39
2CTB813952R1500	OVR 1N-40-150s P TS	39
2CTB813952R1600	OVR 1N-15-150s P TS	39
2CTB813953R0100	OVR 3N 70 275 s P TS	33
2CTB813953R0200	OVR 3N 40 275 s P TS	33
2CTB813953R0400	OVR 3N 70 275 P TS	33
2CTB813953R0500	OVR 3N 40 275 P TS	33
2CTB813953R0600	OVR 3N 15 275 P TS	33
2CTB813953R0700	OVR 3N 70 275 s P	33
2CTB813953R0800	OVR 3N 40 275 s P	33
2CTB813953R1000	OVR 3N 70 275 P	33
2CTB813953R1100	OVR 3N 40 275 P	33
2CTB813953R1200	OVR 3N 15 275 P	33
2CTB813953R1300	OVR 3N 40 440 s P TS	33
2CTB813953R1400	OVR 3N-70-150s P TS	39
2CTB813953R1500	OVR 3N-40-150s P TS	39
2CTB813953R3100	OVR 3N-15-150 P	39
2CTB813953R4100	OVR 3N 40 440 P	33
2CTB813953R4200	OVR 3N 40 440 P TS	33
2CTB813953R4300	OVR 3N 70 440 s P	33
2CTB813953R4400	OVR 3N 70 440 s P TS	33
2CTB813953R6100	OVR 3N 15 440 P	33
2CTB813953R6200	OVR 3N 40 440 s P	33
2CTB813954R0200	OVR 70 150 s C	39
2CTB813954R0400	OVR 40 150 s C	39
2CTB813954R0500	OVR 40 150 C	39
2CTB813954R0600	OVR 15 150 s C	39
2CTB813954R0700	OVR 15 150 C	39
2CTB815101R0100	OVR T1 25 255	21
2CTB815101R0300	OVR T1+2 25 255 TS	23
2CTB815101R0400	OVR T1 50 N	21
2CTB815101R0500	OVR T1 100 N	21
2CTB815101R0600	OVR T1 3L 25 255 TS	21
2CTB815101R0700	OVR T1 3N 25 255 TS	21
2CTB815101R0800	OVR T1 4L 25 255 TS	21
2CTB815101R1000	OVR T1 1N 25 255 TS	21
2CTB815101R1300	OVR T1 3L 25 255	21
2CTB815101R1400	OVR T1 4L 25 255	21
2CTB815101R1500	OVR T1 1N 25 255	21
2CTB815101R1600	OVR T1 3N 25 255	21
2CTB815101R3900	OVR T1+2 7 275 s P	23
2CTB815101R4000	OVR T1+2 3L 7 275 s P	23
2CTB815101R4100	OVR T1+2 4L 7 275 s P	23
2CTB815101R8700	OVR T1 25 255-7	21
2CTB815101R8800	OVR T1 3N 25 255-7	21
2CTB815101R8900	OVR T1+2 15 255-7	23
2CTB815101R9000	OVR T1+2 3N 15 255-7	23
2CTB815101R9300	OVR T1 25 440-50	21
2CTB815201R0800	OVR HL 15 440 s P TS	23
2CTB815201R0900	OVR HL 15 255 s P TS	23
2CTB815250R0300	OVR HL 15 440 s C	23
2CTB815250R0400	OVR HL 15 255 s C	23
2CTB815303R0400	OVR HL 2L 15 440 s P TS	23
2CTB815401R0400	OVR HL 3L 15 440 s P TS	23
2CTB815501R3800	OVR T1+2 7 275 s C	23
2CTB815503R0400	OVR HL 4L 15 440 s P TS	23



ABB Lightning Protection Group

22, rue du 8 Mai 1945
95340 - PERSAN - FRANCE
Telephone: +33 (0) 1 30 28 60 88
Telefax: +33 (0) 1 30 28 60 79

As part of its on-going product improvement, ABB reserves the right to modify the characteristics or the products described in this document. The information given is not-contractual. For further details please contact the ABB company marketing these products in your country.